



Cook



Cook

Whether entertaining friends or simply caring for your family, Parmco has a cooking solution for you. The entire range of Parmco ovens and freestanding stoves offer you excellent functionality, coupled with superb styling. Designed to deliver an exceptional cooking experience and backed by leading industry warranties, Parmco products are must haves in any modern kitchen.

Freestanding Stoves

Cool Touch Door Technology

Fully ventilated doors, triple glazed glass and advanced cooling combines to produce "cool touch door technology". Through this clever combination of design and functionality, the technology of Parmco's oven doors produces low door temperatures, making it safe for those little fingers.

Gas

Gas 600 Freestanding Stove



Gas 900 Freestanding Stove



AR 600-GAS GAS

AR 900-GAS GAS

Size	600mm	900mm
Oven capacity	56 Litre	107 Litre
Functions	****	****
Oven type	Gas	Gas
Cook top	Gas burner	Gas burner
Can be jetted for LPG or natural gas	√	√
Electrical outlet required	10 amp	10 amp
Cool touch door technology	√	√
Utility drawer	√	√
Flame failure safety	√	√
Digital timer		
Twin fans for fast heat up		
Catalytic self-cleaning panels	√	√

Ceramic

Ceramic Top 600 Freestanding Stove



Ceramic Top 900 Freestanding Stove



Ceramic Top 600 Freestanding Stove



AR 600-CER



AR 900-CER



AR 600-WHC/AR 600-BKC

600mm	900mm	600mm
56 Litre	107 Litre	56 Litre
***** ***	***** ***	***** ***
Electric	Electric	Electric
Ceramic	Ceramic	Ceramic
32 amp	50 amp	32 amp
√	√	√
√	√	√
√	√	√
√	√	√
√	√	√

Freestanding Stoves

Combination

Combination 600
Extendable Legged
Freestanding Stove



AR 600-LEG

Combination 900
Extendable Legged
Freestanding Stove



AR 900-LEG-1

Size	600mm	900mm
Oven capacity	56 Litre	107 Litre
Functions	***** **	***** **
Oven type	Electric	Electric
Cook top	Gas burner	Gas burner
Can be jetted for LPG or natural gas	√	√
Electrical outlet required	15 amp	15 amp
Cool touch door technology	√	√
Utility drawer		
Flame failure safety	√	√
Digital timer	√	√
Twin fans for fast heat up		√
Catalytic self-cleaning panels	√	√

Combination 600 Freestanding Stove



AR 600

Combination 900 Freestanding Stove



AR 900

Combination 600 Freestanding Stove



AR 600-WHT/AR 600-OBS

600mm	900mm	600mm
56 Litre	107 Litre	56 Litre
***** **	***** **	***** **
Electric	Electric	Electric
Gas burner	Gas burner	Gas burner
√	√	√
15 amp	15 amp	15 amp
√	√	√
√	√	√
√	√	√
√	√	√
√	√	√

Freestanding Stoves

Combination

Combination 900
Freestanding Stove
One and a Half Oven

Combination Obsidian
900 Freestanding Stove



Main Oven



Half Oven



FS9S-5-2



AR 900-OBS

Size	900mm		900mm
	Main Oven	Half Oven	
Oven capacity	70 Litre	36 Litre	107 Litre
Functions	***** **	*****	***** **
Oven type	Electric		Electric
Cook top	Gas burner		Gas burner
Can be jetted for LPG or natural gas	✓		✓
Electrical outlet required	20 amp		15 amp
Cool touch door technology	✓		✓
Utility drawer	✓		✓
Digital timer	✓		✓
Flame failure safety	✓		✓
Twin fans for fast heat up			✓
Catalytic self-cleaning panels			✓



Electric

Ceramic

Electric 540 Freestanding Stove

Ceramic 540 Freestanding Stove



FS54R

FS54CER

540mm	540mm
70 / 20 Litre Oven / Grill	70 / 20 Litre Oven / Grill
***** *	***** *
Electric	Electric
Electric (radiant coil elements)	Ceramic
32 amp	32 amp
√	√

Freestanding Stove Specs

Gas

600MM Freestanding Gas Stove with 3 Gas & 1 Wok Burner
AR 600-GAS GAS

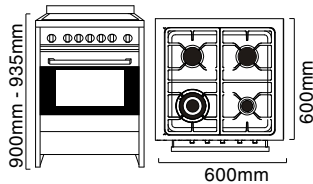

900MM Freestanding Gas Stove with 3 Gas, 1 Wok & 1 Fish Burner
AR 900-GAS GAS

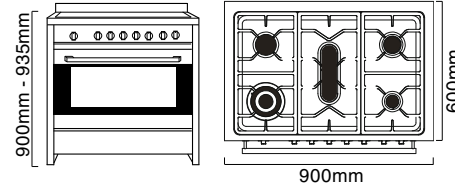

Combination

600MM Freestanding Stove with 3 Gas & 1 Wok Burner
AR-600, AR 600-OBS, AR 600-WHT

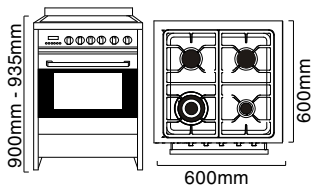

600MM Extendable Legged Freestanding Stove with 3 Gas & 1 Wok Burner
AR 600-LEG

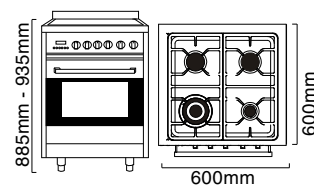

900MM Freestanding Stove with 3 Gas, 1 Wok & 1 Fish Burner
AR-900

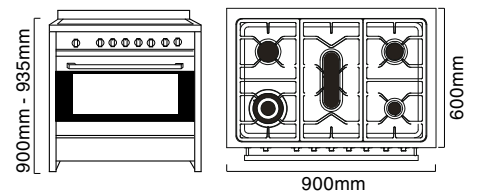

900MM Extendable Legged Freestanding Stove with 3 Gas, 1 Wok & 1 Fish Burner
AR 900-LEG

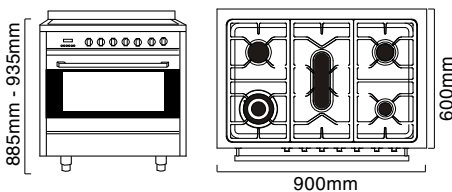

900MM Obsidian Freestanding Stove with 3 Gas, 1 Wok & 1 Fish Burner
AR 900-OBS

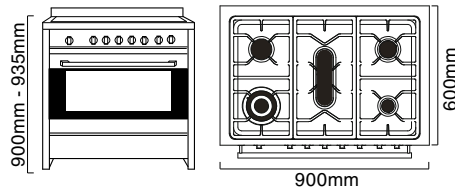

900MM Freestanding Stove, 1 & a Half Door with 3 Gas, 1 Wok & 1 Fish Burner
FS9S-5-2

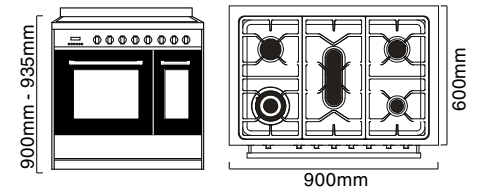

Ceramic

600MM Freestanding Stove with Ceramic Top
AR 600-CER, AR 600-BKC, AR 600-WHC

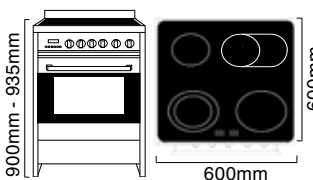

900MM Freestanding Stove with Ceramic Top
AR 900-CER

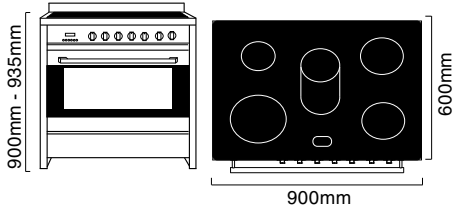

Ceramic/Electric

540MM Freestanding Stove
FS54R / FS54CER

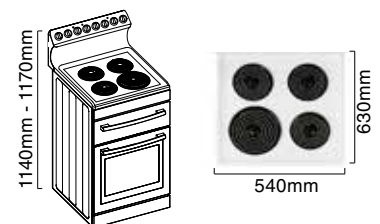

Pyrolytic, Electric or 70L capacity...

What type of oven is best for your home?

Your home is unique to you and your family which means you need to choose the type of oven that best suits your needs. At Parmco, we have a wide range of ovens that perform cooking duties in different ways. But how do you choose the perfect fit? Here are a few helpful tips to explain the different functions performed by different types of ovens, to help you make the best decision for your home.

Pyrolytic

By selecting the Pyrolytic function the oven door locks and temperatures reach up to 450 degrees! All the grease and fat burns to a crisp for you to simply wipe out the inside of the oven. Oven's door may require additional cleaning.

Best thing is, it works on the roasting dishes too.

Electric

Parmco's built-in electric ovens have a full range of cooking functions and temperatures, giving you more control and flexibility.

What's more, all Parmco ovens have an A class energy efficiency!

Featuring triple glazed cool touch door technology, Parmco's oven doors produce low door temperatures making it safe even for the little fingers to touch.

70L capacity

Parmco offer you the option of different oven sizes and capacity's to suit every cooking style. With our 60cm built-in ovens providing a huge 70L usable capacity, you can fit a family size roast or any large dish.



Inbuilt Ovens

70L capacity ovens

With Parmco's new 60cm built-in ovens providing a huge 70L usable capacity, you can fit a family size roast or any other large dish. Two bright lights combined with the large viewing window on the outer door, allow you to clearly see what's going on in the oven. Finished in a stunning black glass with stainless steel edge, this range creates a classic yet modern design to match your kitchen. Plus, with the touch control panel and easy to read display, you have all functions under your control!

70L Multi-zone oven

Different cooking zones in one oven give you greater flexibility and control when you want it. It's simple: heat only the zone you want – top, bottom, multizone or as one large zone. Each zone is independent of the other, so you can select different functions and temperatures at the same time! Heating only the zone you need is also energy and time efficient!

Electric

Electric 11 series Inbuilt Oven



Electric Touch Inbuilt Oven



PPOV-6S-TFT

PPOV-9S-48

Size	600mm	900mm
Usable oven capacity	70 Litre	105 Litre
Functions	***** **	***** **
Oven type	Electric	Electric
Electrical outlet required	15 amp	15amp
Timer	Digital Touch	Digital Touch
Fan forced cooking	✓	✓
Cool touch door technology	✓	✓
Telescopic rails	✓	✓
European A-level energy efficiency	✓	✓
Child lock	✓	✓
Touch controls	✓	✓
Catalytic self-cleaning panels	✓	✓



Electric Touch Inbuilt Oven



Electric Double Inbuilt Oven



Main Oven



Top Oven



PPOV-6B-9

PPOV-6S-DT-2

600mm	600mm	
65 Litre	57 Litre	35 Litre
***** **	**** **	****
Electric	Electric	
15 amp	20amp	
Digital Touch	Digital Touch	
√	√	
√	√	
√	√	
√	√	
√	√	

Inbuilt Ovens

Electric

Pyrolytic Oven

This is the oven you have to have in your kitchen. The PPOV-6S-PYRO-1 in stainless steel is 600mm wide and comes with digital touch display, retractable selector knobs, quadglaze cool touch door and child safety lock. The PPOV-6S-PYRO-1 has ten cooking functions including the pyrolytic cleaning mode. When the pyrolytic function is selected the oven door locks and temperatures reach up to 450 degrees! All the grease and fats burn to a crisp for you to simply wipe the inside of the oven.

Electric Pyrolytic Inbuilt Oven



Electric Touch 70L Multi-zone Inbuilt Oven



PPOV-6S-PYRO-1

PPOV-6S-MULTI-1

Size	600mm	600mm
Useable oven capacity	65 Litre	70 Litre
Functions	***** *****	***** ***** **
Oven type	Electric	Electric
Electrical outlet required	15 amp	20 amp
Timer	Digital Touch	Digital Touch
Fan forced cooking	√	√
Cool touch door technology	√	√
Telescopic rails		√
European A-level energy efficiency	√	√
Child lock	√	√
Touch controls		√
Catalytic self-cleaning panels		√
Pyrolytic function	√	

Electric 8 series Inbuilt Oven



OV7-3-6S-8

600mm
70 Litre
***** **
Electric
15 amp
Digital Touch
✓
✓
✓
✓
✓

Electric 8 series Inbuilt Oven



OV7-2-6S-8

600mm
70 Litre
***** **
Electric
15 amp
Digital Touch
✓
✓
✓
✓
✓

Electric 8 series Inbuilt Oven



OV7-1-6S-8, OV7-1-6W-8

600mm
70 Litre
***** **
Electric
15 amp
Digital Touch
✓
✓
✓
✓
✓

Inbuilt Ovens

All Parmco ovens offer precise cooking control with excellent multi-functions, including fan forced, grilling and even catalytic self clean panels on selected models.

And more importantly, **all Parmco ovens have an A class energy efficiency.**

What is European A-Level energy efficiency?

The European Energy Efficiency of the appliance is rated in terms of a set of energy efficiency classes from A to G, A being the most energy efficient, G the least efficient. This means that the appliance is using less energy to provide the same level of performance. All Parmco ovens have an A class energy efficiency. This is achieved by a new insulation system which ensures that the heat is kept in the oven. It also avoids overheating of the external surfaces, giving the ovens the extra benefit of having cool touch doors.

Electric

Electric 5 series Inbuilt Oven



OV7-3-6S-5

Electric 5 series Pushbutton Inbuilt Oven



OV7-2-6S-5

Size	600mm	600mm
Usable oven capacity	70 Litre	70 Litre
Functions	*****	*****
Oven type	Electric	Electric
Electrical outlet required	15 amp	15 amp
Timer	Mechanical	Mechanical
Fan forced cooking	√	√
Cool touch door technology	√	√
Telescopic rails		
European A-level energy efficiency	√	√



Electric 5 series Inbuilt Oven



OV7-1-6S-5, OV7-1-6W-5

600mm
70 Litre

Electric
15 amp
Mechanical
√
√
√

Inbuilt Ovens

All Parmco ovens offer precise cooking control with excellent multi-functions, including fan forced, grilling and even catalytic self clean panels on selected models.

And more importantly, **all Parmco ovens have an A class energy efficiency.**

What is European A-Level energy efficiency?

The European Energy Efficiency of the appliance is rated in terms of a set of energy efficiency classes from A to G, A being the most energy efficient, G the least efficient. This means that the appliance is using less energy to provide the same level of performance. All Parmco ovens have an A class energy efficiency. This is achieved by a new insulation system which ensures that the heat is kept in the oven. It also avoids overheating of the external surfaces, giving the ovens the extra benefit of having cool touch doors.

Electric

Electric Touch Inbuilt Oven



OV-M1-6S-9

Electric Touch Inbuilt Oven



OV-M2-6S-9

Size	600mm	600mm
Usable oven capacity	65 Litre	65 Litre
Functions	***** ****	***** ****
Oven type	Electric	Electric
Electrical outlet required	15 amp	15 amp
Timer	Digital Button	Digital Button
Fan forced cooking	✓	✓
Cool touch door technology	✓	✓
Telescopic rails		
European A-level energy efficiency	✓	✓
Child lock	✓	✓



Gas

Gas Inbuilt Oven



OV-1-6S-GAS

600mm

56 Litre

Gas - can be jetted for LPG / NG

10 amp

Mechanical

√

Inbuilt Ovens Specs

Electric

8 Function Electric Touch Inbuilt Oven
PPOV-6S-70

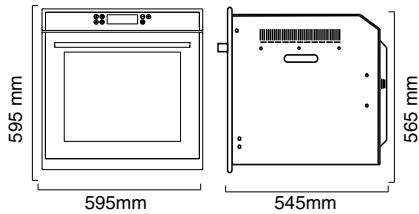

12 Function Electric Multi-zone Inbuilt Oven
PPOV-6S-MULTI-1

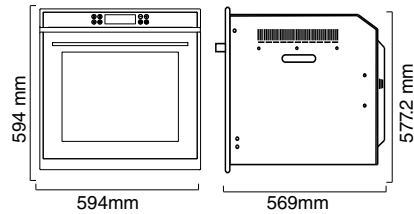

10 Function Electric Pyrolytic Inbuilt Oven
PPOV-6S-PYRO-1

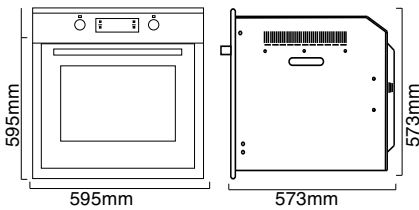

10 Function, 900mm Electric Touch Inbuilt Oven
PPOV-9S-48

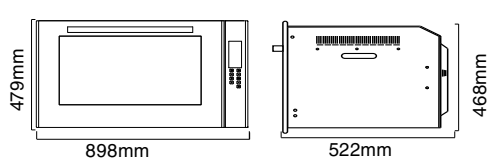

8+4 Function Electric Double Inbuilt Oven
PPOV-6S-DT-2

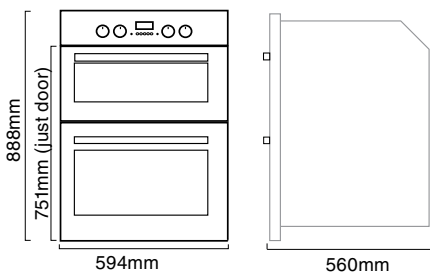

9 Function Electric Touch Inbuilt Oven
PPOV-6B-9

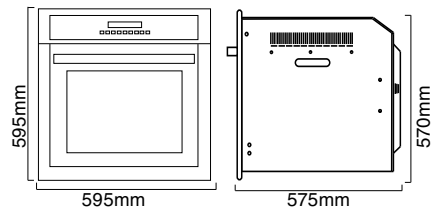

Inbuilt Oven Specs



Gas

8 Function Electric Inbuilt Oven (8 Series)
**OV7-1-6W-8 / OV7-1-6S-8, OV7-2-6S-8,
OV7-3-6S-8**

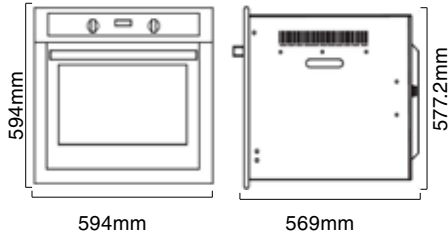

4 Function Gas Inbuilt Oven
OV-1-6S-GAS

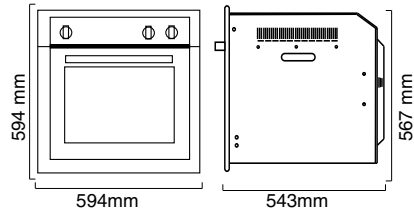

9 Function Electric Inbuilt Oven (8 Series)
OV-M1-6S-9, OV-M2-6S-9

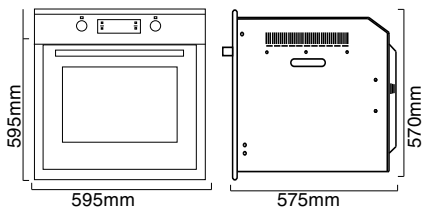

5 Function Electric Inbuilt Oven (5 Series)
**OV7-1-6W-5 / OV7-1-6S-5, OV7-2-6S-5,
OV7-3-6S-5**

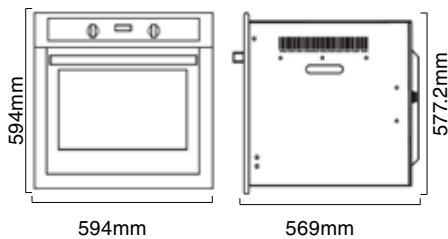

11 Function Electric Inbuilt Oven
PPOV-6S-TFT

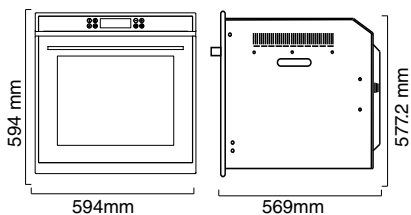

Microwaves

Microwave

30L Microwave



Combination Microwave



MW-1

MW-1-COMBI

Size	520mm	520mm
Capacity	30 Litre	30 Litre
Power settings	*****	*****
Microwave output power	900 watts	900 watts
Microwave input power	1450 watts	1450 Watts
Electrical outlet required	10 amp	10 amp
Timer	Digital	Digital
Internal light	√	√
Stainless steel interior	√	√
Easy defrost	√	√
Combination microwave oven		√
Oven grill option		√



Microwave Specs

Integrated Microwave Oven

Microwave Oven



MWM-1

594mm
25 Litre

900 watts
1450 watts
10 amp
Digital
✓
✓
✓
✓
✓

Microwave

Stainless Steel 30L Microwave MW-1

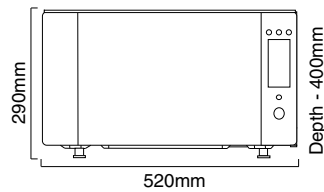

Microwave & Grill Oven

Stainless Steel 30L Combination Microwave MW-1-COMBI

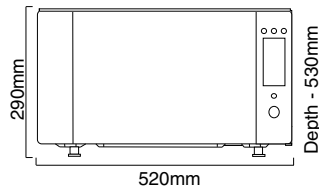

Stainless Steel 25L Integrated Microwave Oven MWM-1

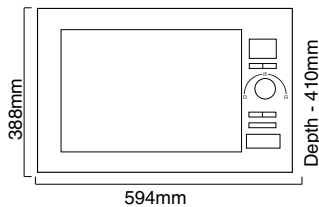

Oven Installation Requirements

PPOV & OV Oven Model

OV7-1-6S-5 & OV7-1-6W-5
 OV7-1-6S-8 & OV7-1-6W-8
 OV7-2-6S-5
 OV7-2-6S-8
 OV7-3-6S-5
 OV7-3-6S-8
 PPOV-6S-MULTI-1
 PPOV-6S-TFT

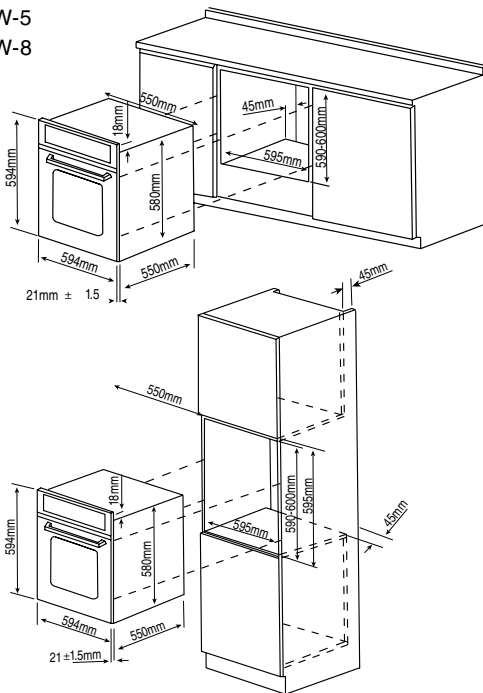

OV-1-6S-GAS

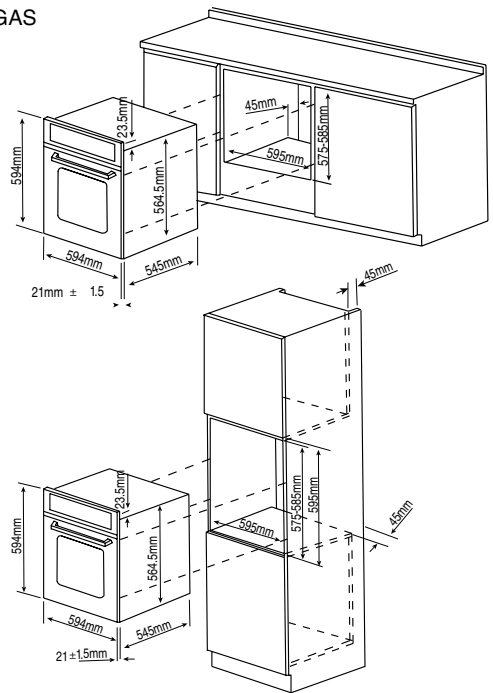

PPOV & OV Oven Model

PPOV-6S-PYRO-1
 PPOV-6B-9
 OV-M1-6S-9
 OV-M2-6S-9

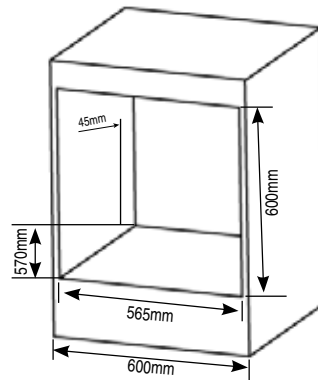
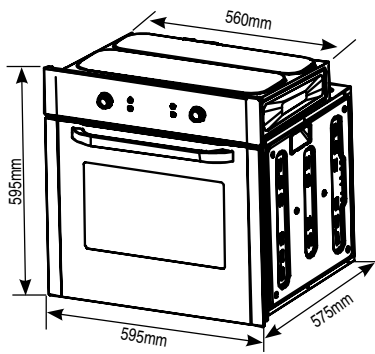

70L PPOV Oven Model

PPOV-6S-70

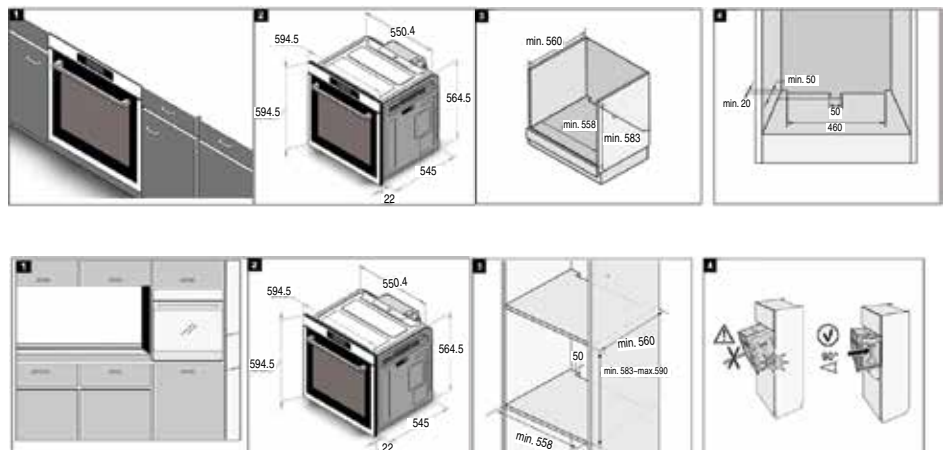



PPOV Oven Model

PPOV-1-6S-DT-2

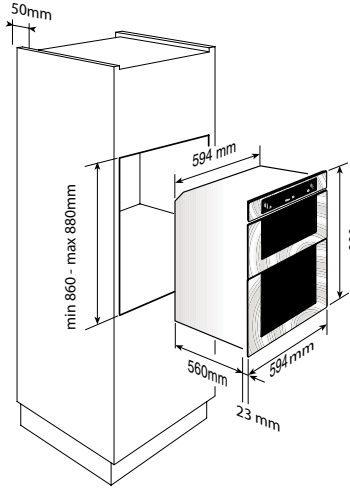
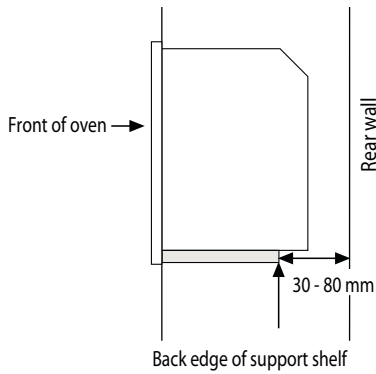

PPOV-9S-48

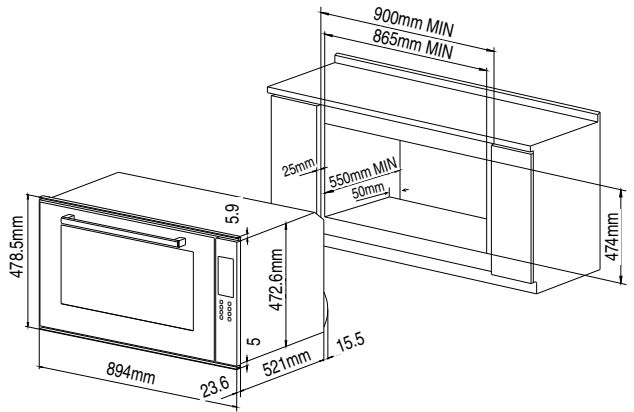

Combination Microwave Oven

MW-1-COMBI

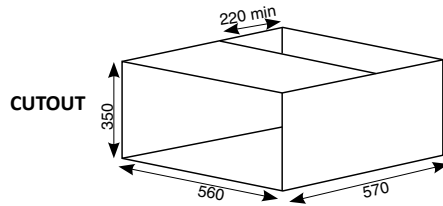
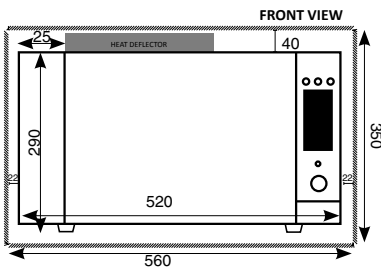

SIDE VIEW

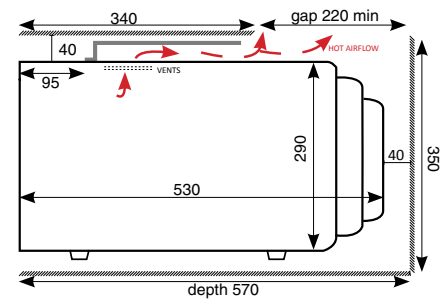

Combination Microwave & Grill

MWM-1

MW-1-TRIM Trim Kit For MW-1 Microwave Oven

*PLEASE NOTE: The trim kits sizes and instructions included here are only to be used as reference. The instructions that come with the Trim Kit are to be used for installation purposes.

Cabinet's inner dimension in transverse direction is 566mm. This is the minimum distance from the left batten to the right batten. Do not alter.
Cabinet's inner dimension in lengthways direction is 366mm. This is the minimum distance from the top batten to the bottom batten. Do not alter.

Cabinet's depth should be no less than 550mm.

Outside dimension of the cabinet should be no less than 596mm as the frame length is 592mm.

Cabinet's board is between 15mm and 20mm thick.

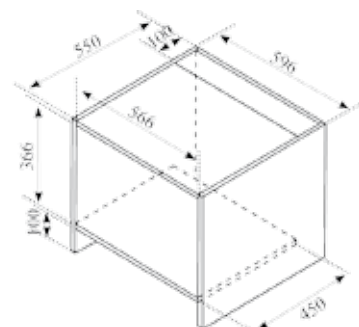
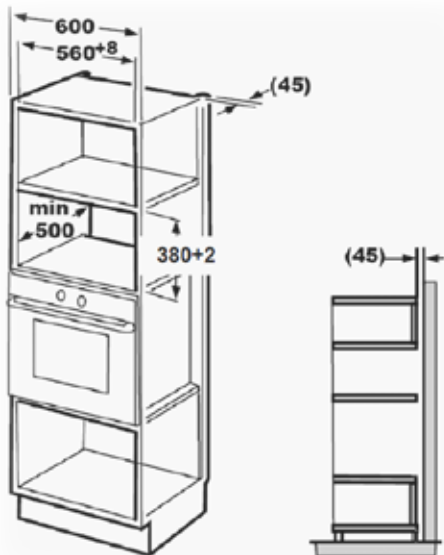

Cooktops

Flexibility and Functionality

Our cooktops range has been designed for maximum flexibility and functionality. Whether you prefer gas, electric, ceramic or induction style cooking we have the size and configuration for you. Easy controls, the latest safety features and easy clean surfaces will enhance your cooking experience.

Gas Cooktops

All gas cooktops are supplied jetted for natural gas at 2kPa. LPG conversion kits are supplied with all gas appliances.

Electric

Electric Cook Top



HOB6W-4E-4



HOB6S-4E-4

Gas

Gas Cook Top



HO-1-2S-2G



HO-1-6W-3GW



HO-1-6S-3GW



Sizes available	Domino, 600mm	Domino, 600mm
Hob type	Electric	Gas Hob
Power settings	***** *	
Heat indicators	√	
Electrical outlet required	30 amp	10 amp
Easy clean surface	√	√
Automatic ignition		√
Flame failure safety		√
Can be jetted for LPG or natural gas		√
Powerful 5.1KW WOK burner		
Low profile design		

Gas Power Burner Cook Top



HO-6-6S-3GW



HO-6-77S-4GW

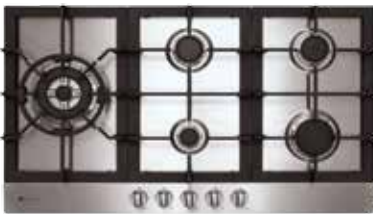

HO-6-9S-4GW

Gas Low Profile Cook Top

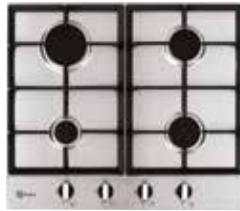

HO-2-6S-4G



HO-2-75S-4GW



HO-2-9S-4GW

Gas Black Glass Cook Top

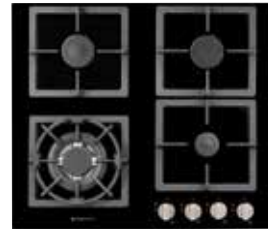

HO-7-6G-3GW

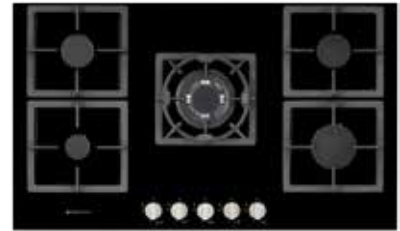

HO-7-9G-4GW



600, 770, 900mm	600, 750, 900mm	600, 900mm
Gas Hob	Gas Hob	Gas Hob
10 amp	10 amp	10 amp
√	√	√
√	√	√
√	√	√
√	√	√
√	√	√

Cooktops

Ceramic

Induction Cooktops

Induction cooking works by using magnetic energy to heat the pot or pan. Put simply, the pot becomes the element. Induction cooking provides instant heat, precise heat control and very efficient energy consumption.

The latest technology of zoneless induction cooking allows you to place pots of various sizes anywhere within the zones and the cooktop will automatically recognise the pot.

Ceramic Cook Top



HO-4-2NF-CER-T*

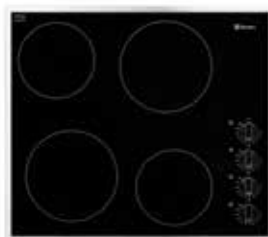

HO-4-6S-CER



HO-4-6NF-CER

Ceramic Touch Cook Top

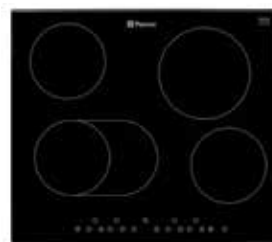

HO-4-6NF-CER-T / HO-4-6S-CER-T



HO-4-77NF-CER-T

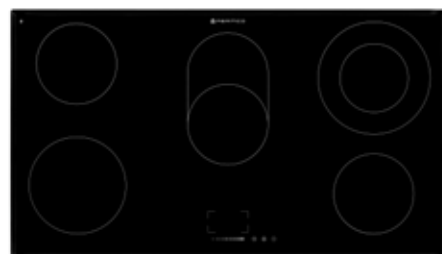

HO-4-9NF-CER-T-1



Sizes available	Domino, 600mm	600, 770, 900mm
Hob type	Ceramic hob	Ceramic hob
Power settings	***** *	***** ****
Control type	*Touch / Knob	Touch
Electrical outlet required	15amp / 30 amp	30 amp
Heat indicators	√	√
Excessive heat protection	√	√
Easy clean surface	√	√
Child lock	√* (HO-4-2NF-CER-T only)	√
Timer function	√* (HO-4-2NF-CER-T only)	√
Boost function		



Induction

Induction
Cook Top

Induction Zoneless
Cook Top

Induction 7 Zone
Cook Top



HO-4-6NF-INDUCT1



HO-4-6NF-ZLINDUCT

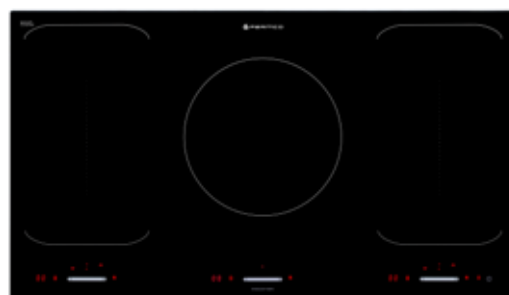

HO-4-9NF-INDUCT



600mm	600mm	900mm
Induction	Zoneless Induction	Induction
***** **	***** **	***** **
Touch	Touch	Touch
30 amp	30 amp	32 amp / 16 amp
√	√	√
√	√	√
√	√	√
√	√	√
√	√	√
√	√	√

Cooktop Specs

Electric

600mm White & Stainless Steel 4
Element Electric Hob
HOB6S-4E-4 / HOB6W-4E-4

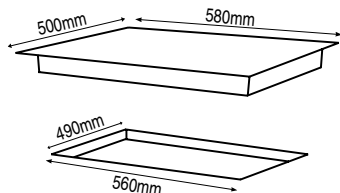

Gas

300mm Stainless Steel 2 Gas Burner
Domino Hob
HO-1-2S-2G

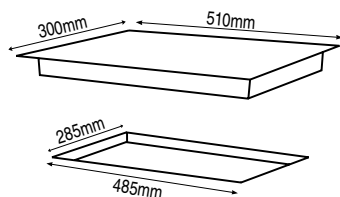

600mm Stainless Steel/White 3 Gas &
1 Wok Burner Hob
HO-1-6S-3GW / HO-1-6W-3GW

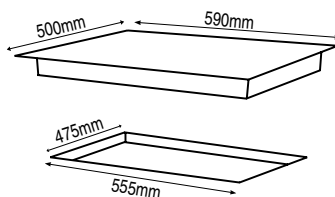

600mm Stainless Steel Low Profile 4
Gas Burner Hob
HO-2-6S-4G

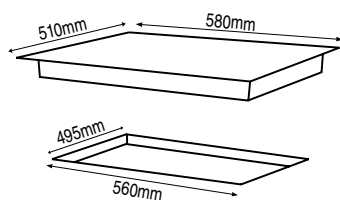

600mm Stainless Steel 3 Gas & 1 Wok
Burner Hob
HO-6-6S-3GW

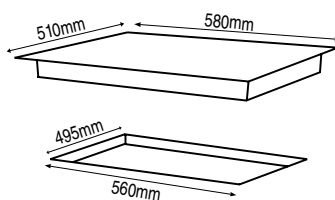

750mm Stainless Steel Low Profile 4
Gas & 1 Wok Burner Hob
HO-2-75S-4GW

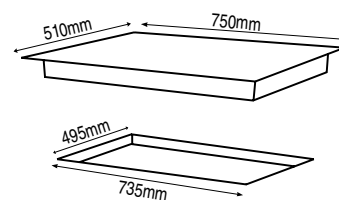

770mm Stainless Steel 4 Gas Burner
Hob
HO-6-77S-4GW

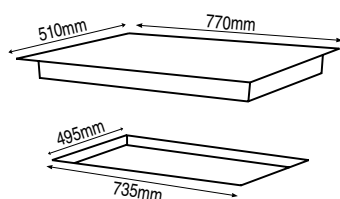

900mm Stainless Steel Low Profile 4
Gas & 1 Wok Burner Hob
HO-2-9S-4GW

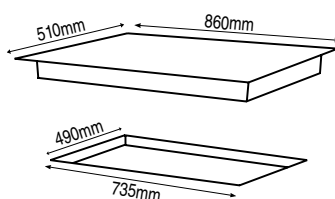

900mm Stainless Steel 4 Gas & 1 Wok
Burner Hob
HO-6-9S-4GW

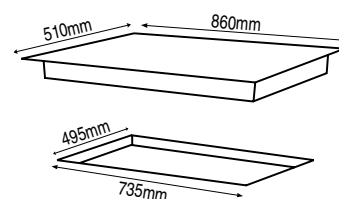

Gas

600mm Black Glass 3 Gas & 1 Wok
Burner Hob
HO-7-6G-3GW

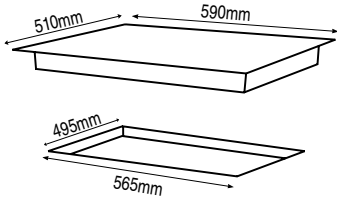

900mm Black Glass 4 Gas & 1 Wok
Burner Hob
HO-7-9G-4GW

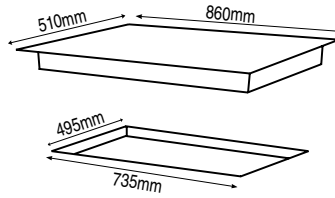

Ceramic

Ceramic Domino Hob with Touch
Controls
HO-4-2NF-CER-T

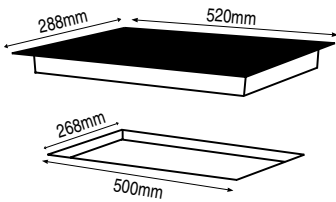

600mm Ceramic Hob, Stainless
Steel frame
HO-4-6S-CER / HO-4-6S-CER-T

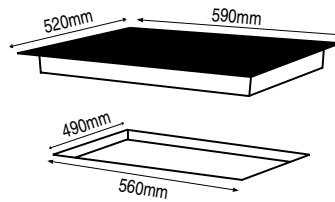

600mm Frameless Ceramic Hob
HO-4-6NF-CER

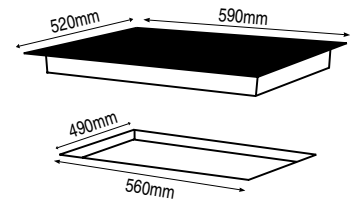

600mm Ceramic Hob with Touch
Controls
HO-4-6NF-CER-T

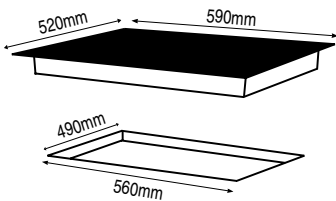

770mm Frameless Ceramic Hob with
Touch Controls
HO-4-77NF-CER-T

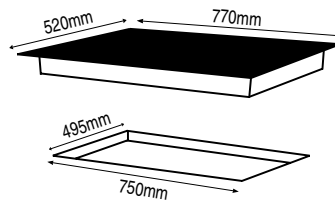

900mm Frameless Ceramic Hob with
Touch Controls
HO-4-9NF-CER-T-1

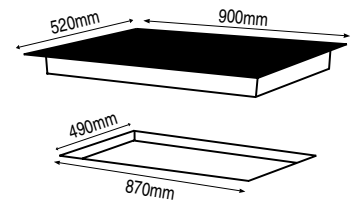

Induction

600mm Frameless Induction Hob with
Touch Controls
HO-4-6NF-INDUCT1

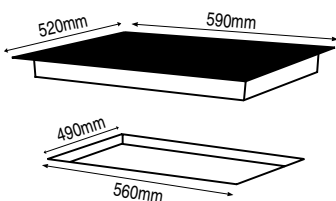

600mm Zoneless, Frameless Induction
Hob with Touch Controls
HO-4-6NF-ZLINDUCT

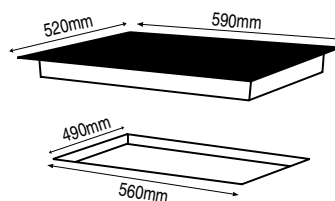

900mm Frameless Induction Hob with
Touch Controls
HO-4-9NF-INDUCT

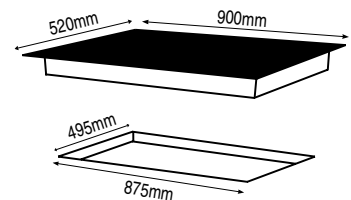

Accessories

Oven Trays & Accessories

Griddle-1
520mm long x 270mm wide



Griddle-2
378mm long x 248mm wide



AR CAT-600 / AR CAT-900
Catalytic Liners compatible with
600 and 900mm AR stoves range



Wire Rack
Available for most models



Cookie Tray
Tray-3: 310mm x 200mm,
Tray-6: 310mm x 370mm,
Tray-9: 380mm x 500mm

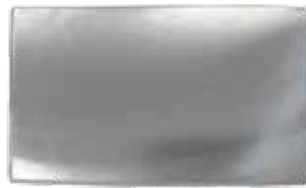

Roasting Dish



Cook Top Trivet & Accessories

Heavy Cast Iron



Scraper



Microwave Accessories

Microwave Trim Kit
MW-1-TRIM

The 30 Litre Microwave from Parmco can be built in to your cabinetry with the fantastic MW-1-TRIM Trim Kit as well as the MW-1-COMBI combination microwave.



Induction, Electric or Gas...

What type of cooktop is best for your home?

Your home is unique to you and your family which means you need to choose the type of cooktop that best suits your needs. At Parmco, we have a wide range of cooktops that perform cooking duties in different ways. But how do you choose the perfect fit? Here are a few helpful tips to explain the different functions performed by different types of cooktops, to help you make the best decision for your home.

Induction

An induction cooktop works by using magnetic energy to heat the pot or pan, put simply - the pot is the element.

Induction cooking provides very fast heat up, precise heat control and very efficient energy consumption.

The latest technology of zoneless induction cooking allows you to place pots of various sizes anywhere within the zones and the cooktop will automatically recognise the pot.

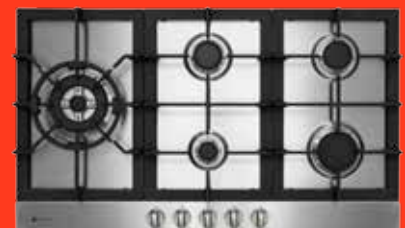

Electric

Parmco's electric cooktops are easy to use and clean.

Featuring two or four elements, including a rapid heat element marked by a red spot, the cooktop gives you great control in selecting a cooking temperature suitable for all types of cooking.

Gas

With a sleek stainless steel design combined with durable cast iron trivets, a gas cooktop is suitable even for the most passionate cooks.

With two, four and five powerful burners including wok burner, you have the convenience of selecting a slow simmer or a powerful setting for stir-fries and steaks.