

# Installation and Operating Instructions

## Models:

**OV7-1-6W-5**

**OV7-1-6W-8**

**OV7-1-6S-5**

**OV7-1-6S-8**

**OV7-2-6S-5**

**OV7-2-6S-8**

**OV7-3-6S-5**

**OV7-3-6S-8**

For your convenience, we recommend to attach the serial number label HERE.



# PARMCO

Dear Valued Customer,

Thank you and congratulations on purchasing your new Parmco appliance.

All Parmco products are made to the highest quality and design standards. We are sure you will enjoy your new appliance.

As a note, please read through these instructions carefully. These will assist you in gaining a complete understanding of the functions and features offered by your appliance. Please take special note of all detailed technical information and installation instructions. It is essential that you follow these instructions to ensure the safety and reliability of this appliance.

Furthermore, not using appropriate personnel to install this appliance may affect any future warranty claims lodged, so please check with Parmco Appliances before any installation is carried out.

We hope you enjoy your new appliance. If you would like to find out more about this product or any other products in Parmco's extensive range, visit us online at [www.parmco.co.nz](http://www.parmco.co.nz).

Regards,

**The Parmco Team**



Cook



Vent



Clean



Cool



Laundry

# INDEX

<b>Important Safety Information</b>	<b>PAGE</b>
Before Using this Appliance	4
For your Safety	4
<b>Use and Care</b>	
Description of the appliance	6
Oven functions	7
Use and care of appliance	8
Electronic Timer	9
Practical cooking advise	13
Cooking guide	14
Maintenance	15
<b>Installation Instructions</b>	
Notes to the Installer	19
Electrical connection	20
Installation into cabinetry	21



## IMPORTANT NOTE

**It is the law in New Zealand that this appliance must be installed by authorised persons. The installation must comply with all the appropriate New Zealand Standards and Regulatory Requirements with particular reference to the New Zealand Electrical Standards.**

**Any attempt to install this or any other Parmco product without an authorised person could result in damage to the product and a possible health hazard. Not having an authorised person install this appliance may result in all associated warranties from Parmco Appliances being null and void.**

# IMPORTANT SAFETY INFORMATION

We recommend that for best performance and to extend the life of your appliance you read the instructions in this owner's manual thoroughly before using your new appliance. It will provide you with all the information you need to ensure its safe installation, proper use and maintenance. Retain this owner's manual for future reference.

To maintain the efficiency, and safety of this appliance we recommend the following:

## **BEFORE USING THIS APPLIANCE**

### **Read the instructions thoroughly**

- Remove all plastic protective films on the appliance before operating the appliance.
- Remove the plastic film on the oven glass door (when provided).
- To condition the oven for its first use, it is necessary to allow oils and residues used to protect the appliances during manufacturing to burn off. Heat the empty oven at maximum temperature for 45 minutes. This allows unpleasant smells and smoke from protective oils used during manufacture and from new thermal insulation to burn off.
- Allow the unit to cool off and wash the oven out with soapy water and then rinse.

## **FOR YOUR SAFETY**

- This appliance is designed for non-commercial, household use only and must not be altered in any way.
- This appliance can only be used safely when it is correctly connected to an efficient earthing system in compliance with New Zealand Electrical Standards requirements.
- Before maintenance or cleaning, always ensure that the appliance is disconnected from the mains.
- Always use oven gloves to remove and replace cookware in the oven.
- Packaging items such as plastic bags, polystyrene, nails, etc that this appliance is delivered in are potentially dangerous, and therefore appropriate measures must be taken to prevent children from coming into contact with them.
- This appliance must only be used by adults. Make sure that children do not touch the controls or play with the appliance. Young children should be supervised to ensure they do not play with the appliance.
- Do not allow children to sit on or play with the oven door.
- Do not use the drop down door as a stool to reach overhead cabinets.
- This appliance is not intended for use by persons (including children) with reduced physical, sensory, mental capabilities, or lack of experience and knowledge, unless they have been given supervision or instruction concerning the use of this appliance by a person responsible for their safety.
- During use the appliance becomes hot. Care should be taken to avoid touching heating elements inside the oven.
- Keep the appliance thoroughly cleaned. Food residues may cause fire risks.
- DO NOT use a steam cleaner to clean this appliance.



- NEVER line the oven with aluminium sheets as doing so may damage the enamel and elements.
- **WARNING:** Accessible parts may become hot during use. To avoid burns young children should be kept away.
- Do not use harsh abrasive cleaners or sharp metal scrapers to clean the oven door glass since they can scratch the surface, which may result in shattering of the glass.
- After using the appliance, please ensure that all controls are in the “OFF” position.
- Avoid touching the oven with wet body parts.
- Avoid improper or dangerous use of this appliance.
- Do not obstruct the ventilation or heat dissipation slots.
- Do not allow power cables of other appliances to come into contact with hot parts of this appliance.
- This appliance is intended for indoor use only. Avoid exposing the appliance to atmospheric elements such as direct sunlight and rain.
- **DO NOT USE OR STORE FLAMMABLE MATERIALS IN THE APPLIANCE OR NEAR IT.**
- For any enquiries please contact Parmco Appliances (09) 573 5678.

# PRODUCT DESCRIPTION

## Controls

- Electronic Programmers (8 Function Models)

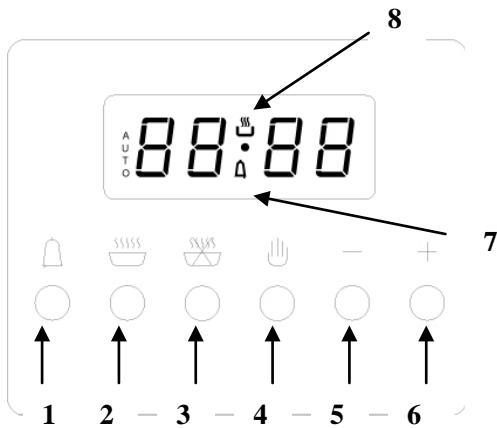

1. Timer
3. End cooking time selector
5. Adjust backwards selector
7. Timer indicator
9. Clock selection indicator

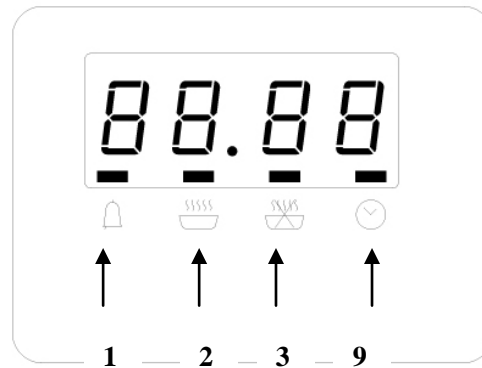

2. Cooking time selector
4. Manual operation selector
6. Adjust forward selector
8. Cooking indicator

### 5-FUNCTION MODEL

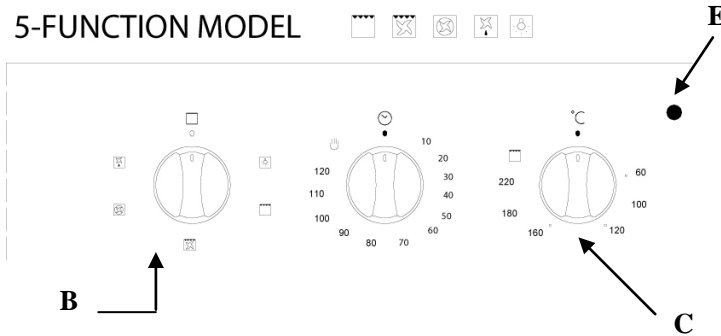

### 8-FUNCTION MODEL

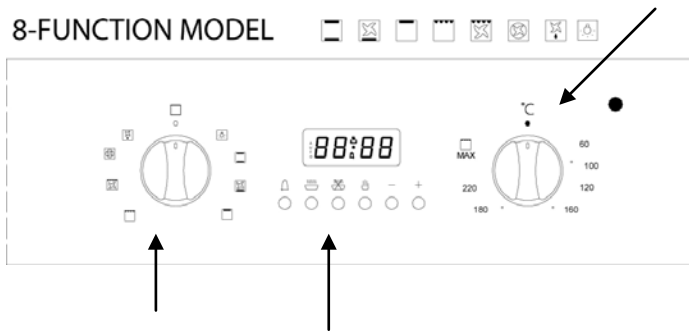

### 5 and 8 PUSH BUTTON MODEL

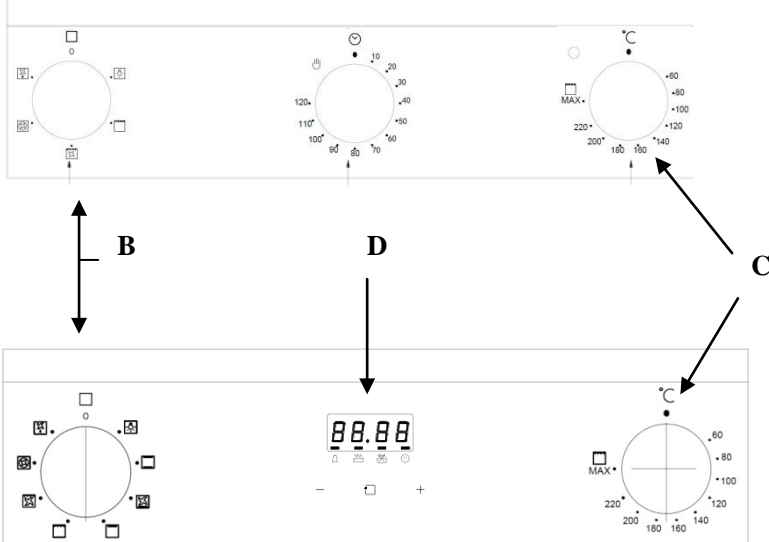





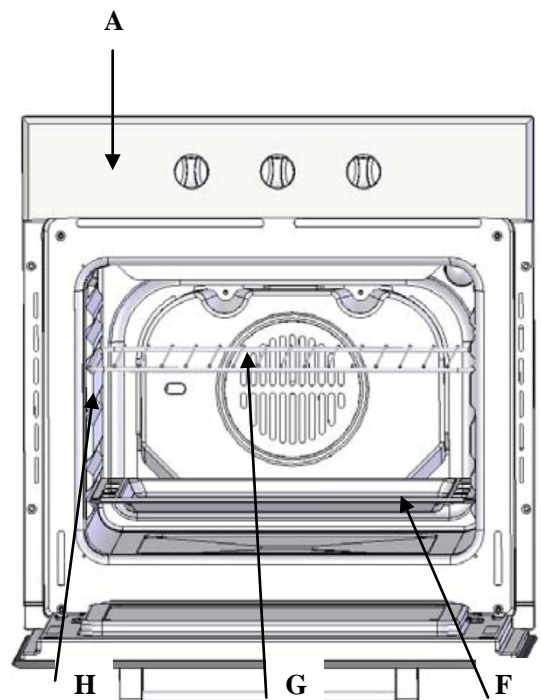



## Description of Appliance

- Control panel
- Cooking mode selection knob
- Cooking temperature selection knob
- Electronic programmer.
- Oven indication light (certain models only)
- Dripping pan or baking sheet
- Oven wire rack
- Easy clean side racks



# OVEN FUNCTIONS

**NOTE: To use your oven in manual mode (not using the end time cooking programmer), the  symbol must be selected on the control knob.**

Symbol	Function description
	<b>Oven light:</b> Turns on the oven light.
	<b>Defrost:</b> The fan located at the back of the oven circulates room temperature air around the oven. This is recommended for defrosting all types of food, but is particularly effective at defrosting delicate food items.
	<b>Conventional cooking:</b> The top and bottom elements are on at the same time. The oven needs to be pre-heated first to the desired temperature. Conventional mode is best suited for traditional baking and roasting. You should only use one shelf at a time; otherwise there will be uneven heat distribution.
	<b>Fan assisted bottom bake:</b> The bottom element and the fan will operate. This mode is most suitable for pizza and pastries that require heat from the bottom.
	<b>Grill:</b> The inside radiant element and top element are both operating. The temperature can be set between 180-250C°. Always grill with the door closed.
	<b>Fan assisted grill:</b> The inside radiant element and top element are working together with the fan. The fan distributes the heat evenly throughout the oven. The temperature can be set between 180-250C°. Always grill with the door closed.
	<b>Fan forced cooking:</b> This function uses the rear element and fan which provides a delicate heat that is evenly distributed throughout the oven. This function is ideal for baking and cooking foods on multiple shelves.
	<b>Top bake:</b> When set to Top Heat, the top heating element operates. This function can be used to brown food at the end of cooking.

## **End Cooking knob (I)** (only available on certain models)

These models are equipped with a timer to control when the oven shuts off during cooking. Position the timer knob (I) between 10 minutes and 120 minutes as required. At the end of the selected time period the timer will sound and the oven will turn off.

## **Cooling / Ventilation**

In order to keep the exterior of the appliance cool, the appliance is fitted with a cooling fan that operates automatically. When the oven is on, the cooling fan turns on and you will notice a flow of air exiting between the door and control panel.

**NOTE:** When cooking is finished, the cooling fan will continue operating until the oven has cooled down. The cooling fan will then turn off automatically.

# USE AND CARE OF APPLIANCE

This multi-function oven combines the advantages of traditional conventional ovens with a modern fan assisted oven, all in a single appliance. It is extremely versatile, and allows you to choose easily and safely between different modes. The various cooking modes are selected using the cooking mode selection knob, located on the control panel.

It is important to remember that this oven may perform differently than your previous appliance may have. To obtain the best cooking results, please experiment with temperature, rack height, and cooking times.

Fit the trays and shelves between the two closest wires as shown on the right.

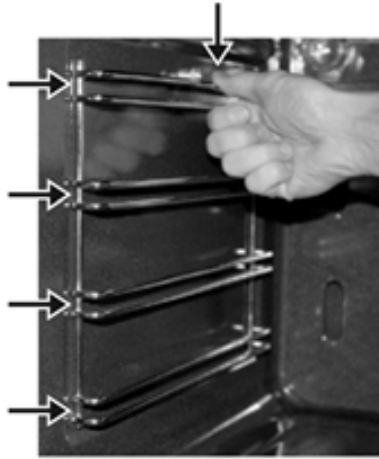

To remove the side support racks, push down on the wire below the locking pin and pull away from the oven wall until you can release the bottom of the support from the holes in the oven wall. To replace, reverse this procedure.

## To operate this oven:

- Ensure that the manual mode is selected.
- Turn the cooking mode selection knob to the desired cooking mode.
- Turn the temperature selection knob to the desired temperature.
- If grilling, turn the temperature selection knob to MAX.

The first time you use your appliance, set the temperature to MAX and select a cooking mode, leaving the empty oven to operate for 30 minutes. Then turn off the appliance and allow it to cool. Any odours during this initial use are due to the evaporation of substances used to protect the appliance during manufacture and storage.

**NOTE:** Place the baking tray provided on the bottom shelf to prevent any spillages from dripping onto the bottom of the oven. **Never place anything (including foil and oven trays) directly on the bottom of the oven when it is in operation as it could damage the enamel.** Place your cookware only (dishes, trays, aluminium foil, etc.) on the oven shelves provided with this appliance.



# ELECTRONIC TIMER

**NOTE:** The clock must be set in order for the oven to operate.

## **6 BUTTON DIGITAL CLOCK (only available on certain models)**

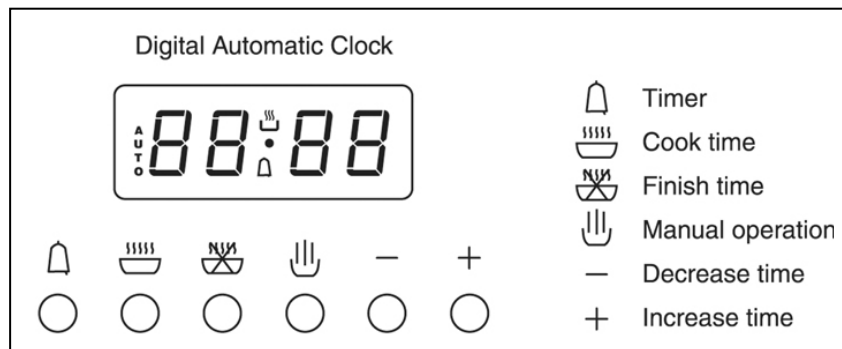

This appliance has a digital display 24 hour clock with six control buttons. When the power is connected, the screen displays 3 flashing numbers and **"AUTO"**.

### **Adjusting the Digital Clock**



To set the correct time, press the  button first and then the + or – button to increase or decrease until the correct time is displayed.

### **Manual Operation Setting**

If **"AUTO"** is flashing, automatic or semi automatic program has been set. Press the  button. **"AUTO"** will clear from the display and the oven can be operated manually.



### **Automatic Setting**



Automatic setting of the oven allows you to select the end time, cooking time, temperature and cooking mode. The oven will switch on, cook according to the selected cooking mode and temperature, then switch off automatically.

1. Press  button, set the cooking time with the + and – buttons.
2. Press  button, set cooking finish time with + and – buttons.
3. Set cooking temperature and cooking mode by turning the thermostat knob and mode selector knob.

After the above setting, **"AUTO"** will illuminate, which means the automatic cooking feature of the oven is set.

**For Example:** If cooking time takes 45 minutes and you want it to finish at 14:00:



1. Press  button, set the cooking time to 45 minutes with the + and – buttons.
2. Press  button, set finish time to 14:00 with + and – buttons.
3. Set cooking temperature and cooking mode by turning the thermostat knob and mode selector knob.

After the above setting, the current time is displayed and “**AUTO**” will flash, indicating that the automatic cooking feature is set. When the clock displays 13:15, the oven will start cooking automatically. While cooking, “**AUTO**” and  will flash. When the clock displays 14:00, the oven automatically stops cooking. The alarm will ring and “**AUTO**” will flash. Press the  button and the ringing will stop.

### **Semi Automatic Setting**

1. Press  button, set cooking finish time with + and – buttons. (Up to 23 hours and 59 minutes).
2. Set cooking temperature and cooking mode by turning the thermostat knob and mode selector knob.

The oven starts immediately,  and “**AUTO**” will flash. At the finish time reached, the oven automatically stops cooking. The alarm will ring and “**AUTO**” will flash. Press the alarm bell to stop the ringing.

When the  button is pressed during semi-automatic cooking, the set cooking time is displayed. If the  button is pressed and the time set back to 0, the semi-automatic setting will be cancelled. When the  button is pressed again, the oven will revert back to manual mode.

### **Timer**

The digital timer can be set up to 23 hours and 59 minutes maximum.

To set the timer, press alarm button  and then + or – button until the desired time is displayed. Once the alarm button is released, the current time and alarm symbol will be displayed. When the alarm button is pressed, the remaining time is displayed. When the set time is reached, the alarm symbol disappears and the alarm will ring. To stop the alarm, press the alarm button.

**NOTE:** After pressing the alarm button, timer settings should be entered within 5 seconds. In case of power failure, all settings including the time display will be lost. When the power is restored, three ‘0’ and “**AUTO**” will be displayed.

### **3 BUTTON DIGITAL CLOCK (only available on certain models)**

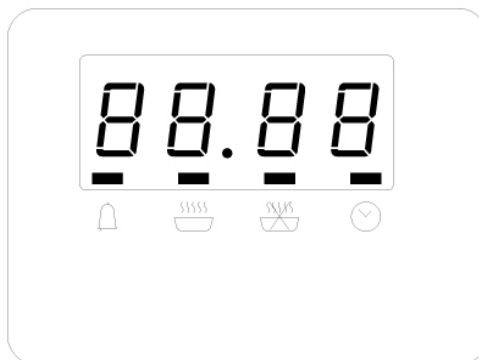





#### **Adjusting the Clock**

Once the oven has been connected to the electrical power, the display will show "12:00" with a square bar highlighted above the  symbol. Press the + or – button to increase or decrease the number until it reaches the correct time. After 5 seconds the clock is set and will start automatically.



#### **Automatic Setting**



Automatic setting of the oven allows you to select the end time, cooking time, temperature and cooking mode. The oven will switch on, cook according to the selected cooking mode and temperature and then switch off automatically.

1. Press the function button repeatedly until the highlighted bar above the  symbol flashes. Set the cooking time with the + and – buttons.
2. Press the function button repeatedly until the highlighted bar above the  symbol flashes. Set cooking finish time with + and – buttons.
3. Select the cooking function and temperature with the control knobs. The symbols above  and  will flash indicating the cooking procedure has been set.

After the above setting, "AUTO" will illuminate, which means the automatic cooking feature of the oven is set.

**For Example:** If cooking time takes 45 minutes and you want it to finish at 14:00:



1. Press  button, set the cooking time to 45 minutes with the + and – buttons.
2. Press  button, set finish time to 14:00 with + and – buttons.
3. Set cooking temperature and cooking mode by turning the thermostat knob and mode selector knob.

After the above setting, the current time is displayed and **"AUTO"** will flash, indicating that the automatic cooking feature is set. When the clock displays 13:15, the oven will start cooking automatically. While cooking, **"AUTO"** and  will flash. When the clock displays 14:00, the oven automatically stops cooking. The alarm will ring and **"AUTO"** will flash. Press  button and the ringing will stop.

## **Start Cooking Now and set the Finish Time**



1. Press  button, set cooking finish time with + and – buttons. (Up to 23 hours and 59 minutes).
2. Set cooking temperature and cooking mode by turning the thermostat knob and mode selector knob.

The oven starts immediately,  and **"AUTO"** will flash. When the finish time is reached, the oven automatically stops cooking. The alarm will ring and **"AUTO"** will flash. Press the alarm bell to stop the ringing.

When the  button is pressed during semi-automatic cooking, the set cooking time is displayed. If the  button is pressed and the time set back to 0, the semi-automatic setting will be cancelled. When the  button is pressed again, the oven will revert back to manual mode.

## **Timer**

The digital timer can be set up to 23 hours and 59 minutes maximum.

To set the timer, press  the function button repeatedly until the square bar above the  symbol flashes, and adjust the time by pressing the + or – buttons. The timer countdown will begin to work. When it reaches the set time, the square bar above the  symbol begins to flash and the alarm will ring. To stop the alarm ringing, press any button.

**NOTE:** when making time and mode selections they must be entered within 5 seconds. In case of power failure, all settings including the time display will be lost. When the power is restored, three '0' and **"AUTO"** will be displayed.

## **The Oven Light**

Set the cooking mode selection knob to  switch on the oven light/s. The oven light/s will stay on while the oven is operating.

## **Cooling / Ventilation**



In order to keep the exterior of the appliance cool, the appliance is fitted with a cooling fan that operates automatically. When the oven is on, the cooling fan turns on and you will notice a flow of air exiting between the door and control panel.

**NOTE:** When cooking is finished, the cooling fan will continue operating until the oven has cooled down. The cooling fan will then turn off automatically.

## Practical Cooking Advice

The oven offers a wide range of settings which allow you to cook any type of food in the best possible way. With time and experimentation you will learn the heat settings, cooking mode and shelf height that will deliver you the results that best match your cooking style. The advice given below is a guideline only which may be varied according to your own personal experience.

### **Pre-Heating of Oven**

If the oven needs to be preheated, the convection mode  or  baking mode should be selected. These are the most efficient modes, which will reach the desired temperature as quickly as possible using the least amount of energy. Once the oven has been pre heated and the cooking mode selected, the food should be placed in the oven.





### **Multi-Shelf Cooking**

If you want to cook food on several shelves, select the “Baking (Fan Forced)” mode . This is the only mode that allows you to cook on multi-shelves at the same time. When cooking delicate foods on more than one shelf, use “Baking Mode” , as this allows you to cook on three shelves.

### **Fan functions**

Some fan functions rely on the air circulation within the oven cavity to provide even temperatures and as such the size and placement of trays can affect the temperature distribution. It is usual to have some temperature variations within the oven cavity and this function is NOT a guarantee of perfectly even temperatures throughout the oven.

# COOKING GUIDE

Selector knob setting	Food Type	Weight (in KG)	Rack height From bottom	PreHeat Time (mins)	Temp Deg C	Cook Time (mins)
<b>Traditional Cooking</b> 	Duck	1	3	15	200	65-75
	Roast Beef	1	3	15	200	70-75
	Roast Pork	1	3	15	200	70-80
	Roast Lamb	1	3	15	200	70-80
	Biscuits		3	15	180	15-20
	Tarts		3	15	180	30-35
<b>Browning</b> 			3/4	15	220	
<b>Grill</b> 	Fish	1	4	5	MAX	8-10
	Kebabs	1	4	5	MAX	6-8
	Vegetables	1	3/4	5	MAX	10-15
	Veal	1	4	5	MAX	15-20
	Cutlets	1	4	5	MAX	15-20
	Hamburgers	1	4	5	MAX	7-10
	Toasted sandwiches		4	4	MAX	2-3
<b>Fan Assisted Grill</b> 	Chicken	1.5	3	5	MAX	55-60
<b>Baking</b> 	Tarts	0.5	3	15	180	20-30
	Fruit cakes	1	2/3	15	180	40-45
	Sponge cake	0.5	3	15	160	25-30
	Small cakes On 2 racks	0.6	2-4	15	190	20-25
	Biscuits on 3 racks	0.7	1-3-5	15	180	20-25
	Meringues on 3 racks	0.5	1-3-5	15	90	180

**Please note the above is a guide only and you will need to vary temperatures, times and rack height combinations to achieve the results you want.**

# MAINTENANCE

## **Cleaning the oven:**

Before cleaning your appliance or performing maintenance, make sure that the cooking mode selection knob and cooking temperature selection knob is set to the **“OFF”** position. To extend the life of your oven, it must be cleaned frequently.

The inside of the oven should be cleaned soon after use when the oven is still warm (not hot) with warm soapy water. The soapy water should be rinsed away and the interior dried thoroughly. Avoid using abrasive detergents, scourers, acidic cleaners etc, as these may damage the enamel. If stains are particularly tough to remove, use cleaners specifically recommended to clean ovens and follow the instructions provided.

**Never use a steam cleaner to clean the inside of this oven.**

If you are using the oven for an extended period of time, or if you are cooking dishes that contain a lot of water, condensation may form on the oven door. Dry it using a soft cloth and try reducing the cooking temperature.

There is a rubber seal surrounding the oven. Check the condition of the seal on a regular basis. If necessary, clean it but avoid using abrasive products or objects to do so. Should it become damaged please contact Parmco Appliances service department. We recommend you avoid using the oven until it has been repaired.



**Never place anything (including foil and oven trays) on the bottom of the oven when it is in operation as this may result in damage to the enamel.**

Clean the glass door using non-abrasive products or sponges and dry it with a soft cloth. Do not use abrasive cleaners or sharp scrapers to clean the oven door glass since they can scratch the surface and may result in shattering of the glass.

## **Catalytic Liners**

The removable catalytic liners are coated with a dark grey catalytic enamel that can become coated with oil and fat distributed by circulating air during convection heating. These deposits will burn off at oven temperatures of 200 °C and higher, for example, when baking or roasting. Higher temperatures will result in faster burning. The oven and accessories should be cleaned after each use. Otherwise further baking and roasting will cause the deposits to bake on even harder and cleaning may become difficult and in extreme cases impossible.

## How to Remove the Oven door

For a more thorough clean, you can remove the oven door. Proceed as follows:

- Open the door to the full extent (Fig.1);
- Open the lever A completely on the left and right hinge (Fig.2);
- Hold the door as shown (Fig.3);
- Gently close the door until left and right hinge levers A are hooked to part B of the door (Dig.4);

Reassemble the door by following the above procedures backwards.

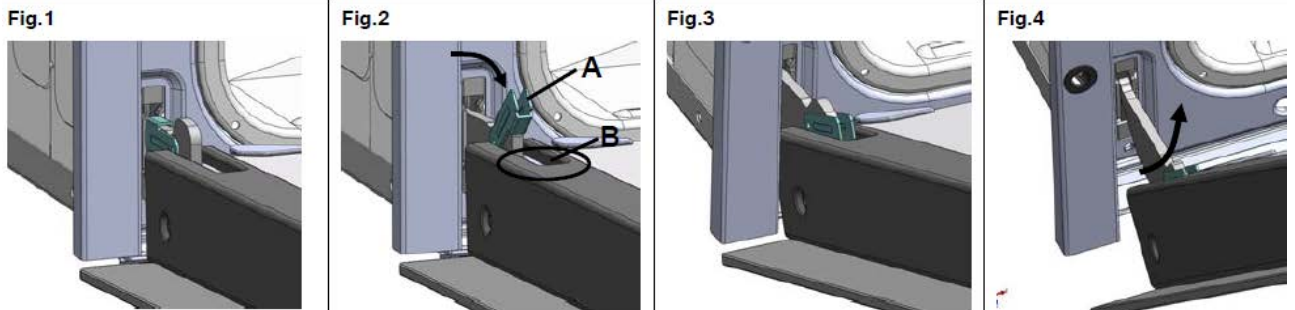

## To dismantle the oven door (two methods)

Method 1 remove and assemble procedure:

- Remove the seal A (Fig.2)、 B、 C(Fig.3) by push the no.2 rods of left and right sides(fig.1)
- Gently pull out the inner and middle panes of glass(fig.4)
- Clean the glass and other components with an appropriate cleaner. Dry thoroughly, and place on a soft surface.

Reassemble the door by following the above procedures backwards.

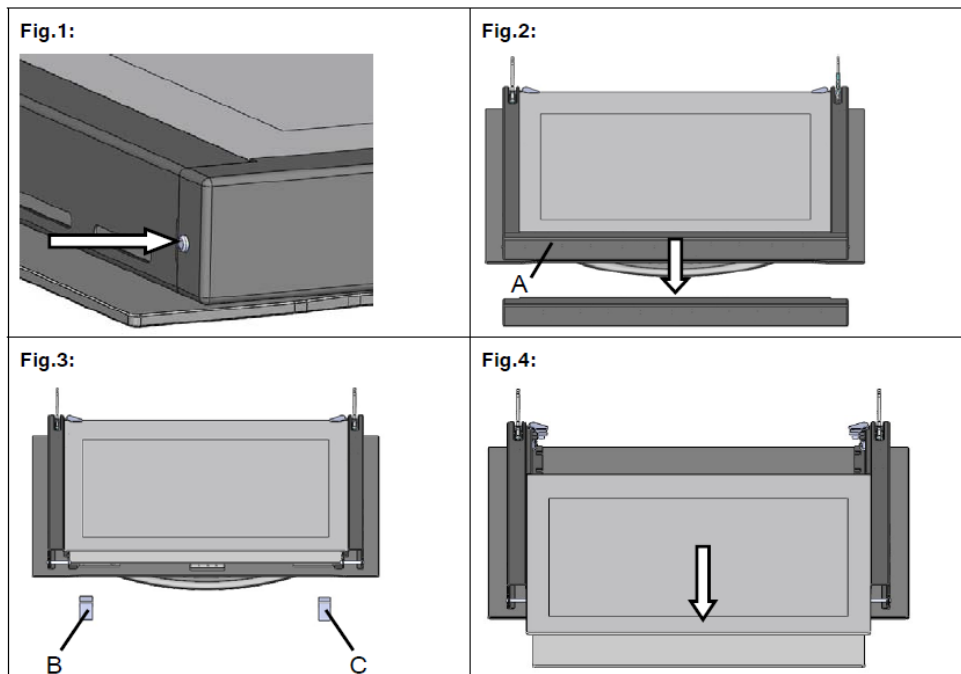

Method 2 remove and assemble procedure:

- Flip the glass pane retainers outwards to open them (Fig.1)
- Gently lift up the inner pane and remove it (fig.2)
- Gently lift up the middle pane and remove it (fig.3)
- Clean the glass and other components with an appropriate cleaner. Dry thoroughly, and place on a soft surface.



Reassemble the door by following the above procedures backwards.

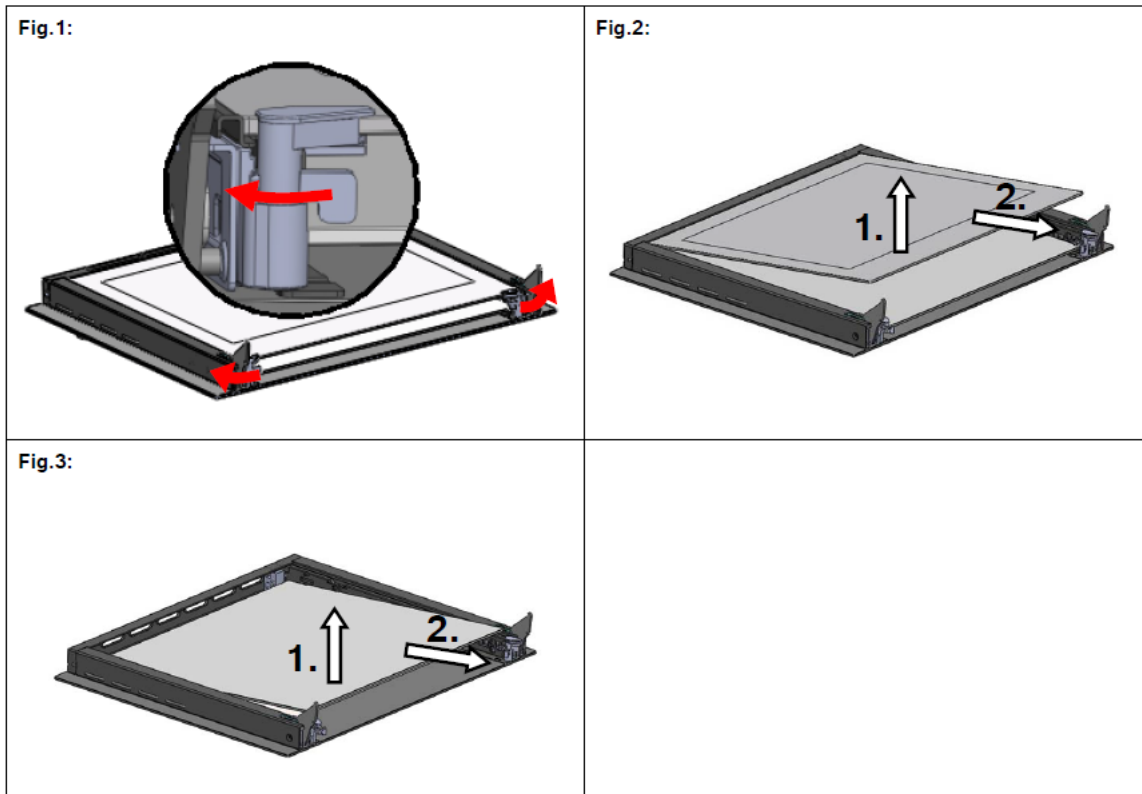

### Replacing the Oven Lamps



**WARNING:** Ensure that the appliance is turned off before replacing the oven lamp/s to avoid the possibility of electric shock.

Remove the glass cover of the lamp-holder as shown below.

Remove the lamp and replace with a lamp resistant to high temperatures (300°C) with the following characteristics.

- Voltage 220 - 240V
- Wattage: 25W
- Type: E14

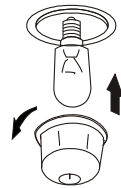

Replacement lamps are available from Parmco Appliances

### **Disposal**

Parmco has a commitment to being environmentally responsible. To avoid potential negative impacts on the environment, please ensure that this appliance is disposed of correctly. This product must not be treated as household waste. Instead it should be handed over to an appropriate collection point for recycling of electrical, electronic and steel components. Disposal should always be carried out in an environmentally appropriate manner. For more detailed information about treatment, recovery and recycling of this product, please contact your local City Council office.

### **Service and Parts**

Before leaving the factory, this appliance was tested and adjusted by specialist skilled staff to give the best operating results. Any subsequent necessary repairs or adjustments must be carried out with the greatest of care and attention by authorised personnel. For this reason, we strongly advise you to contact Parmco Service Department, specifying the nature of the problem, the model and serial number of the appliance. This data is provided on the data label adhered to the base of the appliance and on the duplicate data label in the operating pack.



## **IMPORTANT NOTE**

**It is the law in New Zealand that this appliance must be installed by authorised persons. The installation must comply with all the appropriate New Zealand Standards and Regulatory Requirements, with particular reference to the New Zealand Electrical Standards.**

**Any attempt to install this or any other Parmco product without an authorised person could result in damage to the product and possible health hazard. Not having an authorised person install this appliance may result in all associated warranties from Parmco Appliances being null and void.**

# INSTALLATION

- Installation of this appliance and its connection to the electrical mains must only be carried out by authorised personnel. Before any service procedure, it is important to ensure that the appliance is DISCONNECTED from the electrical mains.
- DO NOT MODIFY THIS APPLIANCE.
- After removing the appliance from the packaging, make sure that it is undamaged. Otherwise, contact your dealer before operating this appliance.
- Make sure that this appliance is installed in accordance with the ventilation requirements.

## NOTES TO THE AUTHORISED INSTALLER



This appliance shall only be installed by an authorised person. This appliance shall only be installed in complete accordance with the Electrical Standards of New Zealand. All local regulations, building code requirements and all other statutory requirements must be met.

### **Data Label**

The data label is located at the rear of the appliance. A duplicate data label is supplied to adhere to a suitable accessible area next to the appliance. The data label on the appliance must NEVER be removed.

Before any procedure, it is important to check that the appliance is DISCONNECTED from the electrical mains. Parmco declines all responsibility for any damage deriving from installations that are in breach of the regulations in force or from failure to comply with these installation instructions.

# ELECTRICAL CONNECTION

The appliance comes fitted with an approved 15 amp cord which may be connected to a correctly earthed socket outlet. It is necessary that all installation and connections are carried out by qualified personnel and that the connections meet all New Zealand Regulatory Requirements.

Before connecting to the mains make sure that:

- The electrical counter, the safety valve, feed cable and socket are suitable to withstand the maximum load requirements as detailed on the rating label.
- The supply system is regularly grounded as per New Zealand Regulations
- The socket or omnipolar switch can easily be reached after the appliance is installed.
- After connection of the appliance to the mains, ensure the cord does not come into contact with any parts of this appliance subject to heating.
- Never use reductions, shunts, adaptors which can cause overheating or burning.

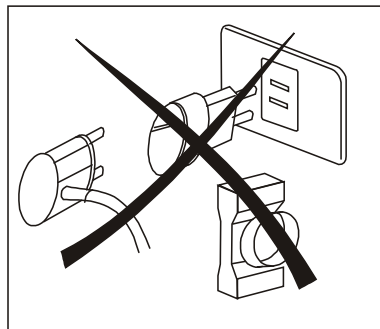

**When handling this oven it is essential that you always use the purpose provided handles recessed into the sides of the oven. This will ensure that the oven carcass and door is not stressed by lifting. DO NOT use the door handle when lifting this appliance into position. This could result in damage to the hinges.**

# INSTALLATION INTO CABINETS



In order for this oven to perform correctly, it requires correct ventilation. Special care must be paid to the ventilations requirements of this oven. The oven must be installed as per the installation instructions below.

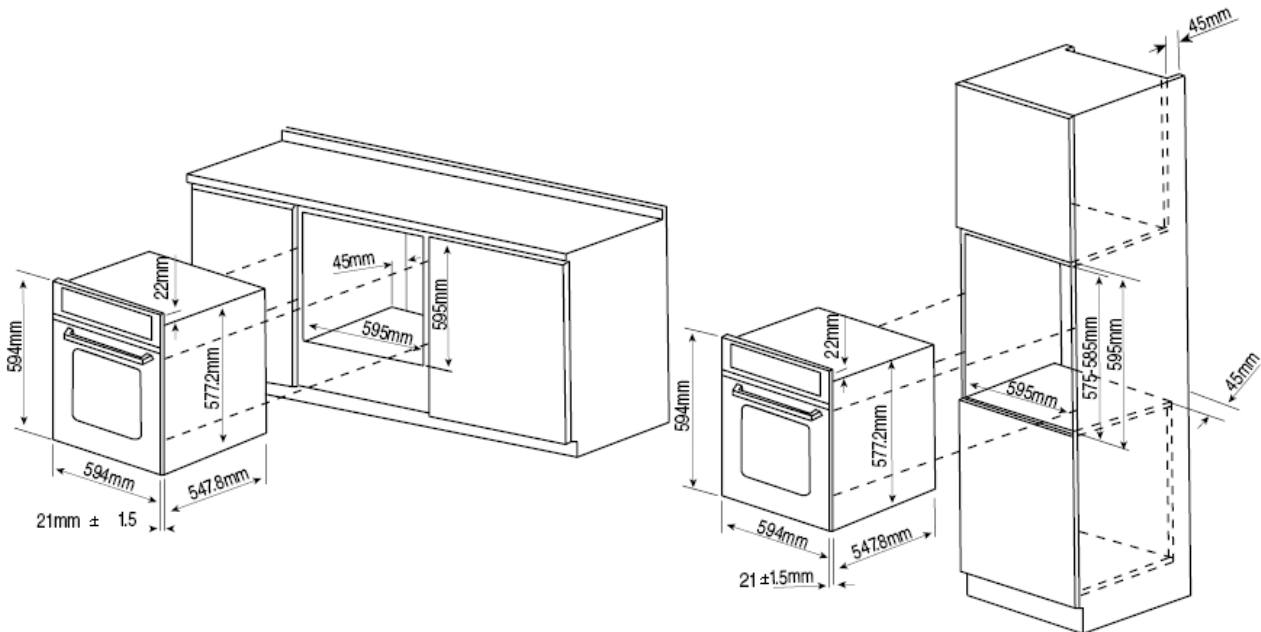

**NOTE: Dimensions provided above for the cut-out are for a face mount only!**

In order to ensure adequate ventilation, the back panel of the cabinet unit must be removed. Installing the oven so that it rests on two strips of wood is preferred. If the oven will rest on a continuous panel there must be an aperture of at least 560mm wide by 45mm deep from the rear of the cabinet.

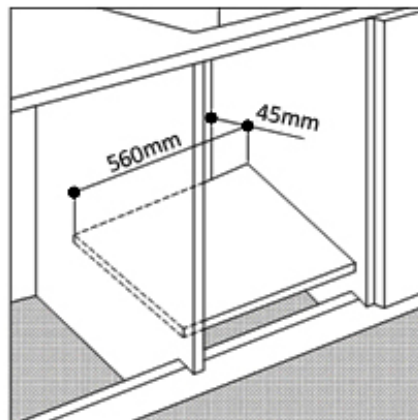
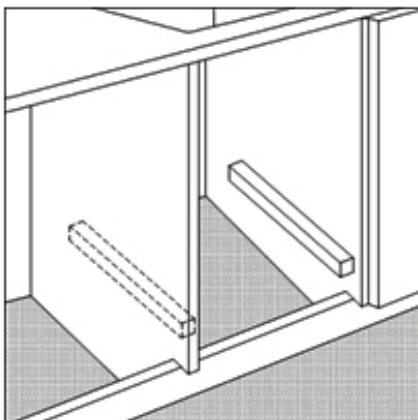

The panels that are immediately adjacent to the oven must be of a material that has heat resistant qualities. In particular, cabinets with veneer finishes must be assembled with glues that can withstand temperatures of up to 100°C. Special attention must be paid to the edge banding finish on the cabinetry. Special care must be taken with vacuum applied veneers commonly referred to as “thermowrap”. If in doubt, always refer to the technical data supplied by the kitchen cabinetry manufacturer.

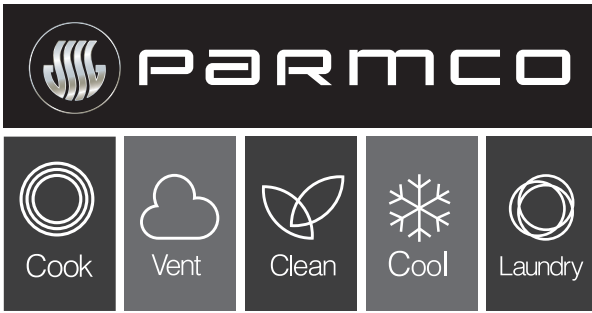

p: 09 573 5678  
 f: 09 573 5699  
 e: sales@parmco.co.nz  
 w: www.parmco.co.nz

# Parmco Appliances extended 5 year warranty



### The Warranty:

- Subject to the terms and conditions contained within this warranty, if the product is not of Acceptable Quality (as defined in the Consumer Guarantees Act) within 5 years of the date of original purchase, then Parmco Sales undertakes to repair or, at its sole discretion, replace the product.
- The warranty does not cover the costs of transport, mileage or travelling time if the product is located beyond 30km of a recognised Service Agent.
- This warranty is offered as an extra benefit, and does not affect other legal rights, which can not be modified or excluded by agreement.
- This warranty only applies to goods supplied and installed in the North and South Islands of New Zealand.
- The provisions of this warranty are in addition to the rights and remedies available to consumers under the Consumer Guarantees Act 1993.
- Products purchased as seconds or thirds may or may not carry a warranty. Please check with your reseller at the time of purchase for the warranty period being offered.

### The Warranty is not valid:

- If the product is not installed and operated in accordance with the operating instructions.
- If the product is not installed to comply with the electrical, gas, plumbing and other Regulations and Codes of Practice in New Zealand.
- If the product is operated on voltages or frequencies outside the normal range for domestic appliances in New Zealand.
- If the product is not used in normal domestic use, or if it is used in a business as defined in the Consumer Guarantees Act.
- If any serial number has been removed or defaced.
- If proof of date of purchase is not supplied, except at the sole discretion of Parmco Sales. Proof of purchase can be for the product itself, or if installed with a kitchen or house then proof of purchase can be from a Parmco reseller of products supplied by Parmco.
- If the products are purchased in a second hand condition from other parties (including but not limited to TradeMe, Sella, etc.)

### Liability under this warranty will not be accepted for:

- Wear and tear from normal domestic use.
- Damage in transport.
- Damage caused to the product by neglect, abuse, negligence, wilful act or misuse.
- Any costs associated with the repair, replacement, removal or reinstallation of products installed in a damaged condition.
- Any defect caused by accident, misuse, neglect, tampering with or unauthorised modifications of the appliance or any attempt at internal adjustment or repair by any person other than an Authorised Service Agent.
- Service calls that relate principally to the following:
  - Instruction on how to use the product.
  - Repair or replacement of house fuses, electrical wiring, gas fitting or plumbing.
- Wear and tear caused by normal use of the product.
- Normal or scheduled maintenance including blocked filters or ducting.
- Consumable items such as light bulbs.
- Any damage to hobs caused by spills when cooking.
- Any breakage or damage of glass items.
- Any damage caused by non recommended product used for cleaning, maintaining, lubricating or similar.
- Any aspect relating to the installation of the product, or damage caused during installation including blocked access for repair.
- Any third party (including reseller) or consequential loss or damage (direct or indirect) however arising.

Product \_\_\_\_\_ Date of purchase \_\_\_\_\_

Dealer / Retailers Name \_\_\_\_\_

Please retain this Warranty card together with receipt or other proof of purchase date when seeking service during the warranty period

Please contact Parmco at 09 573 5678 if your appliance needs servicing under warranty. Please have your model number and proof of purchase ready. Warranty repairs must be authorized by Parmco.