

Installation and Operating Instructions

Model:
PPOV-6S-PYRO-2

For your convenience, we recommend to attach the serial number label HERE.

As part of Parmco Appliances commitment to improving and updating product ranges, we reserve the right to alter, change and update technical specifications and appearance attributes of all Parmco Appliances products. E&OE.

727626022020

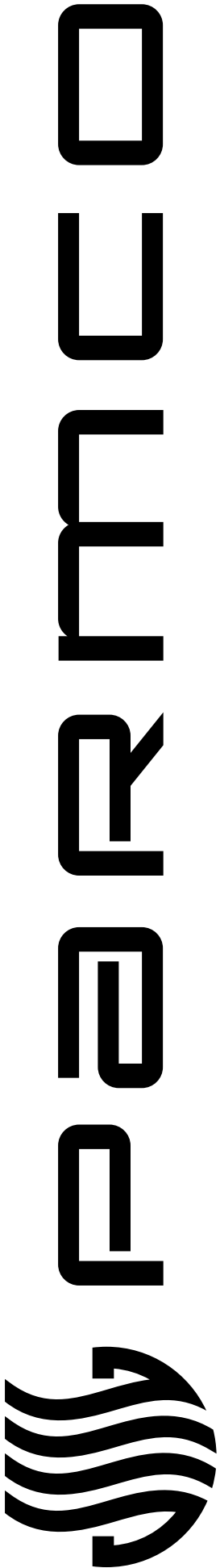



p: 09 573 5678
 f: 09 573 5699
 e: sales@parmco.co.nz
 w: www.parmco.co.nz



Parmco Appliances extended 7 year warranty

The Warranty:

- This appliance is intended for domestic use in the owners' home. Use of the appliance for commercial purposes will limit the warranty period (please see Parmco website for commercial details).
- Subject to the terms and conditions contained within this warranty, if the product is not of Acceptable Quality (as defined in the Consumer Guarantees Act) within 7 years of the date of original purchase, then Parmco Sales undertakes to repair or, at its sole discretion, replace the product.
- The warranty does not cover the costs of transport, mileage or travelling time if the product is located beyond 30km of a recognised Service Agent.
- This warranty is offered as an extra benefit, and does not affect other legal rights, which can not be modified or excluded by agreement.
- This warranty only applies to goods supplied and installed in the North and South Islands of New Zealand.
- The provisions of this warranty are in addition to the rights and remedies available to consumers under the Consumer Guarantees Act 1993.

Product _____ Date of purchase _____
 Serial Number _____
 Dealer / Retailers Name _____

Please retain this Warranty card together with receipt or other proof of purchase date when seeking service during the warranty period

Please contact Parmco at 09 573 5678 if your appliance needs servicing under warranty. Please have your model number and proof of purchase ready. Warranty repairs must be authorized by Parmco.



The Warranty is not valid:

- If the product is not installed and operated in accordance with the operating instructions.
- If the product is not installed to comply with the electrical, gas, plumbing and other Regulations and Codes of Practice in New Zealand.
- If the product is operated on voltages or frequencies outside the normal range for domestic appliances in New Zealand.
- If the product is not used in normal domestic use, or if it is used in a business as defined in the Consumer Guarantees Act.
- If any serial number has been removed or defaced.
- If proof of date of purchase is not supplied, except at the sole discretion of Parmco Sales. Proof of purchase can be for the product itself, or if installed with a kitchen or house then proof of purchase can be from a Parmco reseller of products supplied by Parmco.
- If the products are purchased in a second hand condition from other parties (including but not limited to TradeMe, Sella, etc.)

Liability under this warranty will not be accepted for:

- Wear and tear caused by normal domestic use of the product.
- Damage in transport.
- Damage caused to the product by neglect, abuse, negligence, wilful act or misuse.
- Any costs associated with the repair, replacement, removal or reinstallation of products installed in a damaged condition.
- Any defect caused by accident, misuse, neglect, tampering with or unauthorised modifications of the appliance or any attempt at internal adjustment or repair by any person other than an Authorised Service Agent.
- Service calls that relate principally to the following:
 - Instruction on how to use the product.
 - Repair or replacement of house fuses, electrical wiring, gas fitting or plumbing.
 - Normal or scheduled maintenance including blocked filters or ducting.
 - Consumable items such as light bulbs.
 - Any damage to hobs caused by spills when cooking.
 - Any breakage or damage of glass items.
- Any damage caused by non recommended product used for cleaning, maintaining, lubricating or similar.
- Any aspect relating to the installation of the product, or damage caused during installation including blocked access for repair.
- Any third party (including reseller) or consequential loss or damage (direct or indirect) however arising.



PARMCO

Dear Valued Customer,

Thank you and congratulations on purchasing your new Parmco appliance.

All Parmco products are made to the highest quality and design standards. We are sure you will enjoy your new appliance.

As a note, please read through these instructions carefully. These will assist you in gaining a complete understanding of the functions and features offered by your appliance. Please take special note of all detailed technical information and installation instructions. It is essential that you follow these instructions to ensure the safety and reliability of this appliance.

Furthermore, not using appropriate personnel to install this appliance may affect any future warranty claims lodged, so please check with Parmco Appliances before any installation is carried out.

We hope you enjoy your new appliance. If you would like to find out more about this product or any other products in Parmco's extensive range, visit us online at www.parmco.co.nz.

Regards,
The Parmco Team

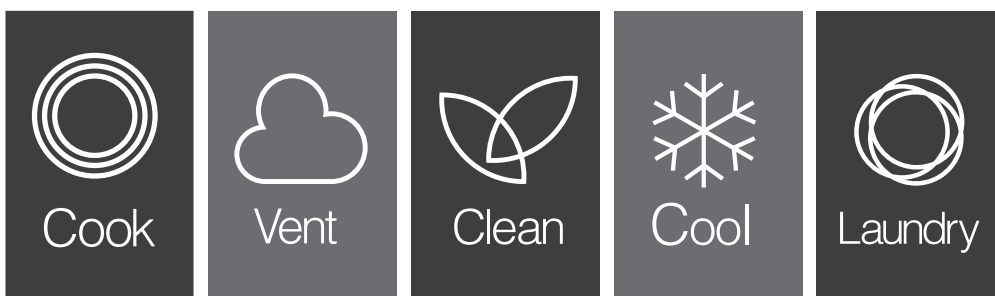

INDEX

Safety instructions	2
How to save energy	3
Unpacking	3
Description of the appliance	4
Installation	5
Operation	7
Prior first use	7
Electronic programmer	7
Oven	8
Cleaning and maintenance	16
Operation in case of emergency	18
Baking in the oven	19
Technical information	24

SAFETY INSTRUCTIONS

The appliance becomes very hot during operation. Take care not to touch the heating elements inside the oven.

WARNING: Accessible parts may become hot during use. To avoid burns young children should be kept away.

Mains lead of adjacent appliances may be damaged by hobs or stuck between the oven doors and produce short circuit, therefore keep them at safe distance from the appliance.

Never put pans on the opened door of the oven, or allow children to stand on the oven open oven door.

Do not use the oven in the event of a technical fault, disconnect the power and report the fault to the service centre to be repaired.

Never clean the oven with the high-pressure steam cleaning device, as it may cause a short circuit.

Do not use harsh abrasive cleaners or sharp metal scrapers to clean the door glass as they can scratch the surface, which could then result in the glass shattering.

The rules and provisions contained in this instruction manual should be strictly observed. Do not allow anybody who is not familiar with the contents of this instruction manual to operate the oven.

During use the appliance becomes hot, care should be taken to avoid touching heating elements inside the oven.

If the supply cord is damaged, it must be replaced by the manufacturer, Its service agent or similarly qualified persons in order to avoid a hazard.

The appliance is not intended for use by persons (including children) with reduced physical sensory or mental capabilities, or lack of experience and knowledge, unless they have been given supervision or instruction concerning use of the appliance by a person responsible for their safety.

Children should be supervised to ensure that they do not play with the appliance.

WARNING: Ensure that the appliance is switched off before replacing the lamp to avoid the possibility of electric shock.

WARNING: The appliance and its accessible parts become hot during use.

Care should be taken to avoid touching heating elements.

Children less than 8 years of age shall be kept away unless continuously supervised

This appliance can be used by children aged from 8 years and above and persons with reduced physical, sensory or mental capabilities or lack of experience and knowledge if they have been given supervision or instruction concerning use of the appliance in a safe way and understand the hazards involved. Children shall not play with the appliance. Cleaning and user maintenance shall not be made by children without supervision.

WARNING: Accessible parts may become hot during use.

Young children should be kept away

HOW TO SAVE ENERGY



Using energy in a responsible way not only saves money but also helps the environment.

So let's save energy! And this is how you can do it:

Make use of residual heat from the oven. If the cooking time is greater than 40 minutes, switch off the oven 10 minutes before the end time. Important when using the timer, set appropriately shorter cooking times according to the dish being prepared.

Make sure the oven door is properly closed.

Heat can leak through spillages on the door seals. Clean up any spillages immediately.

Do not install the oven in the direct vicinity of refrigerators/freezers. Otherwise energy consumption increases unnecessarily.

UNPACKING



During transportation, protective packaging was used to protect the appliance against any damage.

After unpacking, please dispose of all elements of packaging in a way that will not cause damage to the environment.

All materials used for packaging the appliance are environmentally friendly, they are 100% recyclable and are marked with the appropriate symbol.

Caution!

During unpacking, the packaging materials (polythene bags, polystyrene pieces, etc.) should be kept out of reach of children.



DISPOSAL OF THE APPLIANCE

Old appliances should not simply be disposed of with normal household waste, but should be delivered to a collection and recycling centre for electric and electronic equipment.

A symbol shown on the product, the instruction manual or the packaging shows that it is suitable for recycling.

Materials used inside the appliance are recyclable and are labeled with information concerning this. By recycling materials or other parts from used devices you are making a significant contribution to the protection of our environment.

Information on appropriate disposal centres for used devices can be provided by your local authority.

DESCRIPTION OF THE APPLIANCE

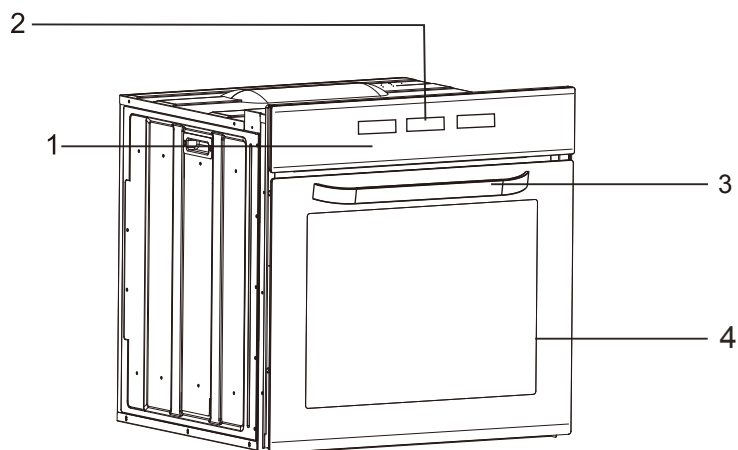

1. Oven operation buttons
2. Display
3. Oven door handle
4. Oven door

CONTROL PANEL

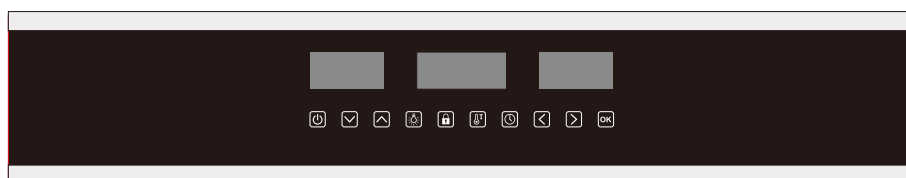

Oven guide levels

Baking pans and accessories (oven grid, baking tray, etc) may be inserted into the oven in 5 guiding levels.

Appropriate levels are indicated in the tables that follow.

Always count levels from the bottom upwards!

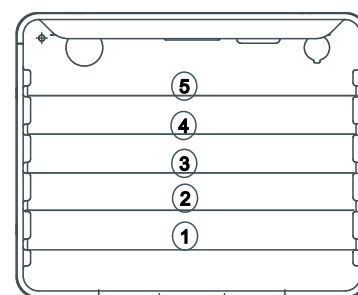

INSTALLATION

▶ Installing the oven

The kitchen should be dry and have effective ventilation according to the existing technical provisions

Main lead behind the oven must be placed in such manner to avoid touching the back panel of the oven because of the heat it develops during operation

Remove any packaging materials (foils, artificial foam, nails, etc.) from the reach of children, because they represent potential danger. Children may swallow small parts, or suffocate with foils/plastics.

This is a built-in oven, which means that its back wall and one side wall can be placed next to a high piece of cabinetry or a wall.

Coating or veneer used on fitted cabinetry must be applied with a heat resistant adhesive (100°C). This prevents surface deformation or detachment of the coating. If you are unsure of your cabinetry's heat resistance, you should leave approximately 2cm of free space around the oven. The wall behind the oven should be resistant to high temperatures. During operation its back side can warm up to around 100°C above the ambient temperature.

Make an opening with the dimensions given in the diagram for the oven to be fitted

The appliance must be earthed.

Insert the oven completely into the opening without allowing the four screws in the places shown in the diagram to fall out.

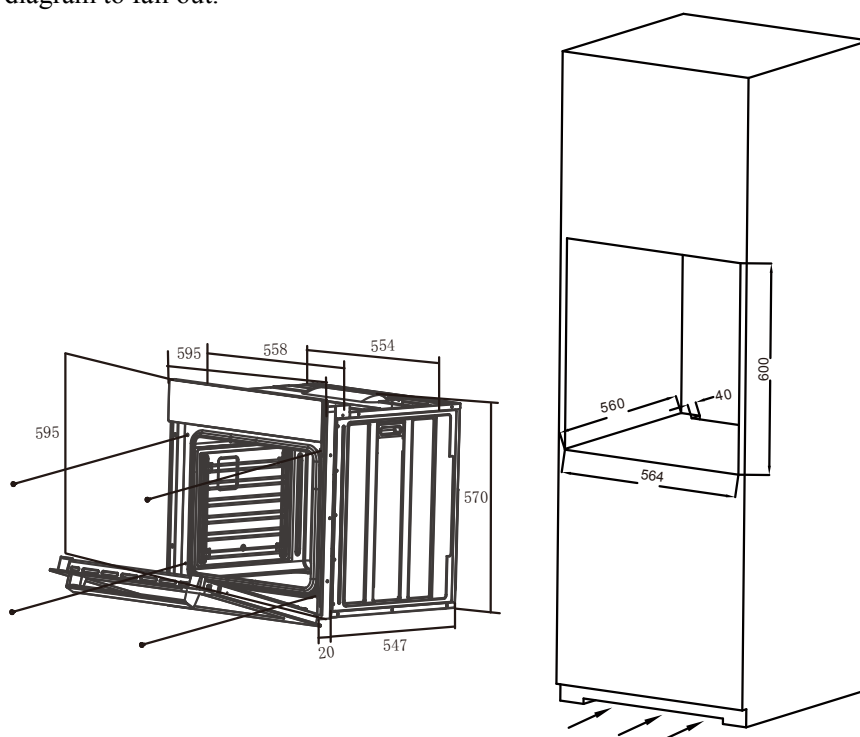

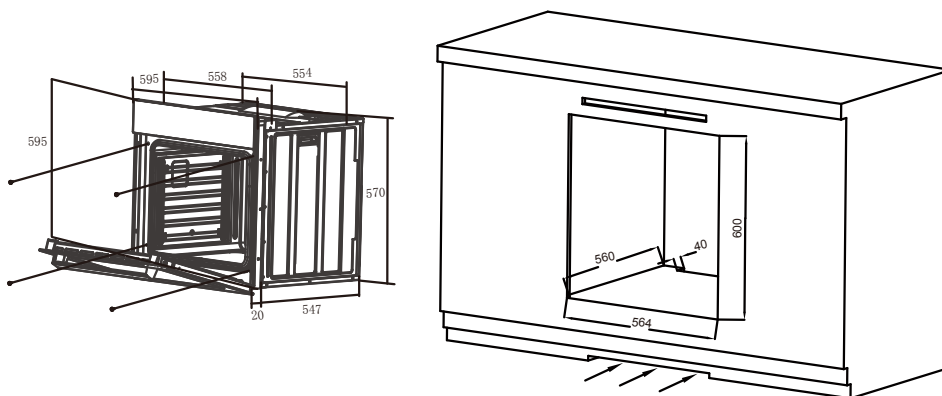

▶ Electrical connection

Warning!

All electrical work must be carried out by a suitably qualified and authorized electrician. No alterations or willful changes in the electricity supply should be carried out.

- Before attempting the connection, check whether the voltage indicated on the rating plate corresponds to the actual mains voltage.
- Mains lead should be minimum 1.5m long.
- Earthing wire should be installed in such manner to be the last one pulled out in case the safety relief device of the mains lead should fail.
- Mains lead behind the oven must be placed in such manner to avoid touching the back panel of the oven because of the heat it develops during operation.
- The cable of correct size rating must be used, cable type H05VV-F 3×1.5 m². The grounding wire shall be longer than the other wires.
- The means for disconnection from the supply mains having a contact separation in all poles that provide full disconnection under over voltage category iii shall be provided in the fixed wiring in accordance with the wiring rules.

Connection (by authorised electrician)

- Using the screwdriver open the connector cover at the rear of the appliance. Release two locks located at either side of the connector bottom.
- Mains lead must be led through the relief safety device, protecting the mains lead cable from disconnection.
- Tighten the relief device securely and close the connector cover.

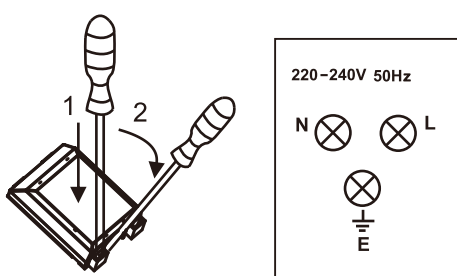

Colour code

L=exterior live wires, usually coloured black, brown.

N=neutral

The colour is usually blue.

Beware of the correct N-connection!

 E=earthing wire, the colour is green/yellow.

OPERATION

▶ Prior first use

- Remove packaging, clean the interior of the oven.
- Take out and wash the oven fittings with warm water and a little non-abrasive washing liquid.
- Switch on the ventilation in the room or open a window.
- Heat the oven (to a temperature of 250°C, for approx. 30 minutes. Remove any stains and wash carefully.

Caution!

When heating the oven for the first time, it is normal phenomenon to give off smoke and peculiar smell. This will disappear about 30 min later.

▶ Electronic programmer

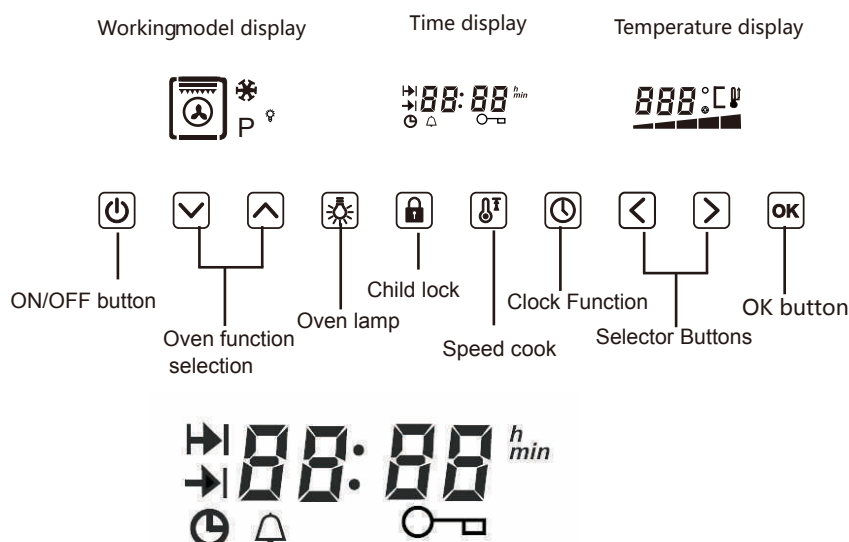

 - Cooking time

 - Timer

 - End of cooking time

 - Current time

 - Child Safety Device

Button	Explanation
ON/OFF button	For on / off the oven.
Oven function selection	For upward downward selection of functional.
Oven lamp	For on / off oven lamp. Select a function, the light will turn on.
Clock Function	Used to set the clock, alarm, cooking time and end of cooking time.
OK button	Used to confirm selection during the heating process.
Selector Buttons	Used to set different temperatures, set the clock, alarm, cooking time, end of cooking time.
Speedcook	Enable rapid pre-heating of oven. After setting the function and temperature, touch this button and the oven will heat to the selected temperature faster.
Child lock button	This enables you to lock the control panel. You must unlock before you can use the oven panel.

Remark:

Use the function and temperature selector at the same time can turn on/off the oven.

Above is the control panel diagram, actual function please refer to product.

Select or set a function, must press button“  ”.

Heating Indicator

When the “  ” is on, that the oven is heating.

Also will show the heating status “  ”, total 5 sections, each present 20% of the setting temperature.

Residual Heat Indicator

After oven stop working, temperature display“  ” show the residual heat information. 5 sections each stand for 20% of setting temperature.



Speedcook

Speedcook function is mainly used for preheating the oven. When the preheating function is not yet complete, you

can by pressing the speedcook button“  ”any time to execute.



do the following:

1. Setting the function and temperature (See steps on page 12 “Feature Selection /temperature regulation”).

2. Touch the rapid cooking button “  ” the temperature display will show “  ”.

the rapid cooking function is activated.

3. This time Top element+Grill+Bottom element+Fan simultaneously work to rapidly increase the internal temperature of the oven to reach the selected temperature in a shorter period of time.

4. After rapid heating to reach the set temperature, Icon “  ” disappears. The “  ” is full grid logo.

5. Oven in step 1 settings continued heating.

Caution

Setting temperature lower than 100°C, you are unable to use the speedcook function .

Child Safety Device

To avoid tampering of operation while the oven is working, the child lock function has been added to this oven series.

1. Touch “  ”button and hold for 5 seconds.

Time display area shows key icon “  ”, the appliance is locked.

2. All the buttons are disabled after the child lock active, and the key icon“  ”, keeps flashing, to show that machine is locked.

3. Touch and hold“  ”button for 5 seconds to unlock.

Caution

Child Safety Device can be used when the ON/OFF button in any position

Lighting function

- Press “  ” to turn on/off the light when power on.
- Light will be automatically turn on while heating, touch key to turn off

“  ” and re-turn on the light.

Caution

When select 20 °C defrost function, the oven light used as a heating element and can- not turn off.

Lighting function can not be turned off while child safety device on.





Automatic shut-off feature

Each mode has a maximum working time, auto shut off function noted in the following criteria:

Temperature 20-120 °C	Working Hours
121-200 °C	24h
201-250 °C	6 h
201-250 °C	4 h

When select oven cook time, its prior to the auto shut off function (assume that set shut off temperature to 201°C-250°C, set cook time to 5 hours, so oven will not auto shut off when working for 4hours, and keep working when reach 5 hours).

When functions conflicts







- Use ON/OFF switch “” turn off the oven, the cooking time (“”) and the end of cooking time (“”) will be cancelled.
- Change the temperature setting during working, time count down stop, press “”, it will continue.
- Press several keys at the same time, functions will not operate.
- Change the function during working, time count down will stop.

Caution!







When use touch control, to get the best result, touch the displays softly and quickly, unless the manual specifically gives alternative directions.

Tips: Make sure your finger and buttons both dry and cool.

How to operate the oven



1. Touch the button “” turn on the oven.
2. Touch button “” or “” to select function.
3. Touch button “” or “” to set temperature.
4. Touch ON/OFF button to switch off the oven “”

Function selection / Temperature regulation

1. Touch ON/OFF button “” to switch on the oven.
2. Heat program display empty “”.
3. Touch button “” or “” to select function.
4. A suggested temperature will appear on display and blinking when function selected.
5. Touch button “” or “” to set the temperature.
6. Touch “” to confirm the selected temperature.
7. Oven starts working.

Caution







- Never put food or tray on bottom of the oven.
- Keep children away.
- Set time before use.
- The temperature scope is 50°C - 250 °C (defrost is 20°C - 60°C) .

- Long press “” and “” can speed up temperature setting.

Setting the time









This is a 24 hour clock, make sure to set the right time before first use.

The clock can be set when the ON/OFF button “” in OFF position.

1. Turn on the oven and the display will show “00:00”.
2. Touch clock button “”, time display “12:00”, and “” keep flashing.
3. Touch “” or “” to set time.
4. Touch button “” or button “” to confirm time, or will auto confirm after 30 seconds.

Timer

To set the timer you should:

1. Touch button “” until the timer “” flashes on the display, and time display “0: 00”.
2. Touch “” or “” to set time.
3. touch button “” to confirm.
4. The “” stop flashing, the time will begin to count down.
5. Alarm sounds when the set time has been reached, and the alarm icon “” will flash.
6. Touch button “”, or “”, the alarm signal will go off. or it will be turned off automatically after 90 seconds.
7. If you want to cancel the timer, you can set the time to “0:00”.



Caution







- Always keep the control panel clean, or the grease may damage the touch panel.
- Touch panel need to be regular cleaned by soft cloth.
- If alarm countdown time, cooking time, and clock functions are set up, the display will show the alarm count down.
- The alarm time range is 1 second to 23 hours 55 minutes. Alarm is just to reminder, it does not turn the oven off.

Semi-automatic operation

This mode is to set the oven cooking time, when time is reached, the oven will turn off and a alarm sound will be heard.

Set the cooking time when ON/OFF button “” is on, and the oven is working:



1. Touch button “” twice, cooking time “” flashes, display shows “0:00”.

2. Touch “” or “” to set the cooking time .
3. Touch “” to confirm, the cooking time “” lights on, time set saved.
4. Set cook time run out, oven stop heating, alarm sounds, the cooking time icon “” and temperature icon both flashing.
5. Touch button “”, or “”, the alarm signal will go off. or it will be turned off automatically after period of time.

For example

Current time is “2:00”, set cook time to 1 hour, so oven stop heating when “3:00”.

Alarm sounds, the cooking time icon “” and temperature icon both flashing.









Touch button “”, or “”, the alarm signal will go off or it will be turned off automatically after period of time.

6. If you want to cancel the cooking time, you can set the cooking time to “0:00”.



Automatic operation



Touch button “” to set end time only after set cook time.

Set end time when the ON/OFF button “” is on, oven is working, and cook time already set

1. Touch button “” for 3 times, the end of cooking time icon “” flashing.
2. Touch “” or “” to set the end of cooking time.
3. Touch “” to confirm, the end of cooking time “” light on, setting is saved.
4. Oven stop heating when reach setting end time, alarm sounds, the cooking time “” and temperature icon both flashing.
5. Touch button “”, or “”, the alarm signal will go off or alarm signal will be turned off automatically after period of time.

For example

The current time is 2:00, set the cooking time to 1 hour, and set the end of cooking time to “3:00”, if not adjust end of cooking time by “”, but touch “” to save, then the oven will stop heating by “3:00”.

If you touch button “” to adjust the end of cooking time to “3:30”, and touch button “” to save, then the

oven start working at “ 2:30”and stop at “ 3:30”

Caution

The cooking time and the end of cooking time range:

Cooking time range: $0 < t \leq 10$ hours

End of cooking time range: $\text{current time} < \text{end of cooking time} \leq \text{current time} + 10$ hours.

End of cooking time = current time + cooking time

End of the work time priority display than the current time

End of the work time priority display than the current time

We suggest that you supervise the first few cooks to make sure time temperature are right.

Then you can make adjustment to avoid over or insufficient cook.

▷ Oven

Possible settings of the oven function knob



Bottom and top elements on

Setting the knob to this position allows the oven to be heated conventionally.



Bottom element

At this oven function knob position, the oven activates the bottom heater.



Full Grill

(Grill and the top element)

When the "combined grill" is active the entire top element is in use.

This function allows a higher temperature at the top of the cooking area, which causes more intense browning of the dish and permits larger portions to be grilled.

Warning!

When using function Grill it is required that the oven door is closed.

Warning!

When the grill is in use accessible parts can become hot. It is best to keep children away from the Oven.



Fan, bottom and top elements on

At this knob position the oven executes the cake function. Conventional oven with a fan.

Caution!

When the functions with fan have been selected but the temperature knob is set to zero only the fan will be on. With this function you can cool the dish or the oven chamber.



Circular fan element on

At this function, allows the oven to be heating up in a forced way with the thermos-fan, which is in the central part of the oven chamber.

Heating the oven up in this way permits even heat circulation around the dish in the oven. The advantage of this heating method is:

Reduction of overheating-up time and of the initial heating stage.

Possibility to bake at two cooking levels simultaneously.

Reduction in the amount of fats and juices coming out of meat dishes, which results in an improvement in taste.



Fan (Defrost)

At this function, only the fan and light work. You can cool the dish or the oven chamber or defrost food.



Circular Fan and bottom elements on

This operates the fan oven with the convection element and the bottom element allowing for cooking with increased temperature from the bottom of the dish when using shelf position 3 or 4. Set the oven operation knob to the function and the default temperature of 220 is displayed. You can adjust the temperature.



Fan and bottom element on

At this oven function, the oven activates the bottom heater and fan function.

The mode is useful for baking loe pastry and preparation of preserved fruit and vegetables.



Pyrolytic Function

This oven can clean itself by a process known as pyrolysis, heating the cavity to a temperature of approximately 430°C. This will burn off the residue from spattering and spillages caused by cooking. Pyrolytic programmes should be used when the oven smokes during preheating or cooking or if the oven smells even when cold. It is not necessary to run a pyrolytic programme after every use of the oven.

Do not wait until the oven is coated in grease to run a pyrolytic programme.

The smoke produced by pyrolysis is broken down by passing through a catalyser.

Please note: Before selecting pyrolytic programme, remove all shelves, trays and other accessories from the oven and clean up any major spills to avoid the risk of fire or excessive smoke.

Do not hang towels or cloths on the oven handle during pyrolysis.

The programme immediately locks the door and starts the cooling fan at a slow setting; the cooling fan speed increases to its maximum when the oven heat builds up.

Note: This function has an added safety feature to prevent it from being selected accidentally. To run the pyrolytic function, select “Pyrolytic” function on the “Function Selector Display”, Then touch the “” key to confirm the selection.



Economy Grill (variable)

Use the economy grill to grill or brown mall amounts of food. Locate the grill pan in the 4th or 5th shelf position. Pre-heat the grill for 5 minutes before use .

Warning!

When the grill is in use accessible parts can become hot. It is best to keep children away from the oven.



Fan grill element

The oven activates the grill top heater and fan function. In practice, this function allows the grilling process to be speeded up an improvement in the taste of dish, you should only use the grill with the oven door shut.

CLEANING AND MAINTENANCE

By ensuring proper cleaning and maintenance of your oven you can have a significant influence on the continuing fault-free operation of your appliance.

Before you start cleaning, the oven must be switched off and you should ensure that all knobs are set to the "0" position. Do not start cleaning until the oven has completely cooled.

▷ Oven

- The oven should be cleaned after each use (not pyrolytic clean).
- Cool the oven completely before cleaning.
- Never clean the appliance with pressurized hot steam cleaner.
- The oven chamber should only be washed with warm water and a small amount of washing-up liquid and completely dried.

• Steam cleaning

-pour 250ml of water (1 cup) into a bowl placed in the oven on the first level from the bottom.

-Close the oven door.

-Set the temperature knob to 50°C, and the function knob to the bottom heater position.

-Heat the oven chamber for approximately 30 minutes.

-Open the oven door, wipe the chamber inside with a cloth or sponge using warm water with washing-up liquid.

- After cleaning the oven chamber wipe it dry.

Caution

Do not use cleaning products containing abrasive materials for the cleaning and maintenance of the glass front panel.

▷ Replacement of the oven light Bulb

Before any maintenance is started involving electrical parts, the appliance must be disconnected from the power supply.

If the oven has been in use, let the oven cavity and the heating elements cool down before attempting any maintenance.

Changing the bulb

Pull out the protective cover. We recommend that you wash and dry the glass cover at this point.

Carefully remove the old bulb and insert the new bulb suitable for high temperatures (300°C) having the following specifications: 220-240V, 50Hz, 25W, G9 fitting.

Refit the protective cover.

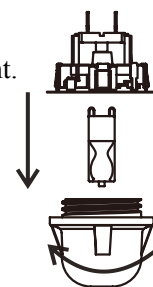

IMPORTANT

Never use screwdrivers or other utensils to remove the light cover.
This could damage the enamel of the oven or the lamp holder. Remove only by hand

Never replace the bulb with bare hands as contamination from your fingers can cause premature failure. Always use a clean cloth or gloves.

Please note:

The bulb replacement is not covered by your warranty/guarantee

Door removal

In order to obtain easier access to the oven chamber for cleaning, it is possible to remove the door. To do this, tilt the safety catch part of the hinge upwards. Close the door slightly, lift and pull it out towards you. In order to fit the door back on to the oven, repeat the process in reverse. When fitting, ensure that the notch of the hinge is correctly placed on the protrusion of the hinge holder. After the door is fitted to the oven, the safety catch should be carefully lowered down again. If the safety catch is not set it may cause damage to the oven.

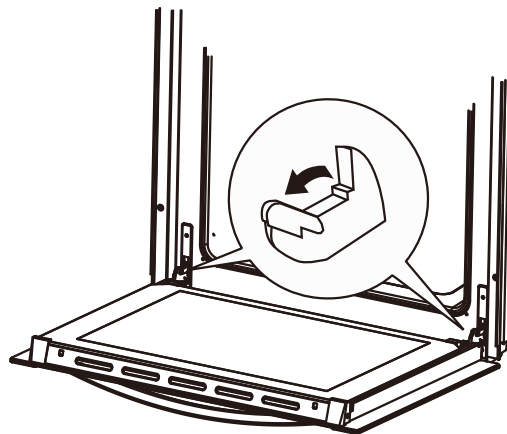

Tilting the hinge safety catches

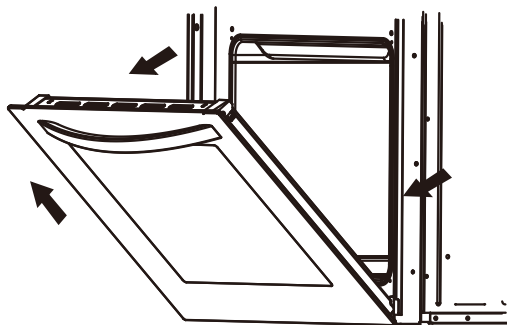

Door removal

▷ Removal of the internal glass panel

Unscrew and unfasten the plastic latch that is in the corner at the top of the door. Next take out the glass from the second blocking mechanism and remove. After cleaning, insert and block the glass panel, and screw in the blocking mechanism.

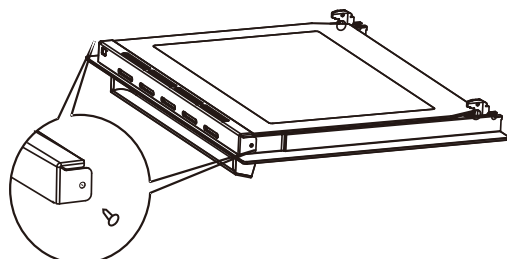

Removal of the internal glass panel

OPERATION IN CASE OF EMERGENCY

In the event of an emergency, you should:

Switch off all working units of the oven

Call the customer support centre

Some minor faults can be fixed by referring to the instructions given in the table below.

Before calling the customer support centre or the service centre check the following points that are presented in the table.

PROBLEM	REASON	ACTON
1. The appliance does not work	Break in power supply	Check the power has been turned on. Check the household fuse box, if there is a blown fuse replace it with a new one
	Incorrect function selected	Check if function and temperature are set as required.
2. The programmer display is flashing "0.00"	The appliance was disconnected from the mains or there was a power outage.	Set the current time (see use of the programmer)
3. The oven lighting does not work.	The bulb is loose or damaged.	Tighten up or replace the blown bulb(see cleaning and maintenance)

BAKING IN THE OVEN

Baking pastry

Most appropriate position for baking is the application of both upper and lower elements, and the fan, or circular fan element.

Warning!

The baking parameters given in tables are approximate and can be adjusted based on your own experience and cooking preferences.

In case you may not find any particular type of cake in the tables, use the information available for the next most similar type of cake.

Baking with upper and lower elements

Use only a single guide level.

This baking position is especially suitable for baking dry pastry, bread and teacakes. Use dark baking pans. Light pans reflect heat and pastry is not adequately browned.

Always place baking pans on the grid rack. Remove the grid only if baking in the flat biscuit tray, supplied with the appliance.

Preheating shortens the baking time. Do not put the cake in the oven until proper temperature is obtained.

Baking tips

Is cake baked?

Pierce the cake with a wooden skewer at the thickest part, if the dough does not stick to it, the cake is baked. You may switch off the oven and use the remaining heat.

Cake has fallen

Check the recipe. Use less liquid next time. Follow the mixing times, especially when using electric kitchen mixers.

Cake is too light on the bottom

Use dark baking pan next time, or place the pan one level lower, or switch on the lower heater a while before the completion.

Cheese cake is undercooked

Next time reduce the baking temperature and extend the baking time.



Warnings regarding the baking tables

The tables indicate the temperature range. Always select lower temperature first. You may always increase the temperature in case pastry needs more baking.

Baking times are indicative only.

The asterix indicates that the oven requires preheating.

BAKING IN THE OVEN

Type of pastry	Guide level(from down upwards)	Temp (°C) 	Guide level(from down upwards)	Temp (°C) 	Baking time (in min)
Sweet pastry					
Sponge cake/ marble cake	2	170-180	2	150-170	60-80
Victoria sponge	2	160-180	2	150-170	65-80
Base for a layer cake	2-3	170-180	2-3	150-170	20-30
Sponge layer cake	2	170-180			30-40
Fruit cake(crispy base)			2-3	160-180	60-70
Cheesecake(shortcrust)			2	140-150	60-90
Teacake	2	160-180	2	150-170	40-60
Bread(e.g.wholegrain bread)	2	210-220	2	150-170	50-60
Fruit cake(crispy base)	3	170-180	2	160-200	35-60
Fruit cake(with yeast)			2	160-170	30-50
Crumble cake	3	160-170		150-170	30-40
Sponge roll	2	180-200			10-15
Piza(thin base)	3	220-240			10-15
Piza(thick base)	2	180-210			30-50
Buns	3	160-170	2	150-160	10-30
Puffpastry	3	180-190	2	170-190	18-25
Meringues	3	90-110		80-90	
Choux buns			2	170-190	35-45

Roasting

Best results are obtained with the engagement of both upper and lower elements. Best heating mode for each type of roasting pan is indicated by bold print in the Roasting Tables.

Tips regarding roasting pans

For best results, use light enamel pans, temperature resistant glass pans, clay dishes or cast iron dishes.

As stainless steel dishes reflect the heat, they are not recommended.

If you cover your roast or wrap it in foil, it will preserve its juices and the oven will remain clean.

The roast will be cooked quicker if it is left uncovered. Large roasts can be placed directly on the grid with the oven tray below for catching the juices and melted fat.

Attention when roasting!

Roasting tables indicate suggested temperatures, guide level and roasting times. Roasting time largely depends upon the type of meat, its size and quality. So you may expect some variations

Roasting of large chunks of meat may produce excessive steaming and condensation on the oven door. This is quite normal, and does not affect the operation of the oven.

However, after the completion of roasting wipe the oven door and the glass thoroughly.



Add as much liquid as necessary to prevent burning of juice, dripping from meat. Roast must be checked regularly and liquid added if necessary.

At approximately the middle of the indicated time turn the roast round, especially if you use the deep roast dish.

When roasting on the grill grid, place the grid in the deep roasting pan and insert both into the sliding guide. The bottom pan will intercept dripping fat.

Never leave roast to cool in the oven, as it might produce condensation and corrosion of the oven.

Roasting Table

Type of meat	Guide level(from bottom up)	Temp (°C) 	Roasting time (in min)	Temp (°C) 	Roasting time (in min)
Beef					Per 1 cm
Roast beef or file rare			3	250	12-15
Oven warmed up juicy(“medium”)			3	250	15-25
Oven warmed up “well done”			3	210-230	25-30
Oven warmed up Roast joint	2	160-180	2	200-220	120-140
Pork					
Roast joint	2	160-180	2	200-210	90-140
Ham	2	160-180	2	200-210	60-90
Fillet			3	210-230	25-30
VEAL	2	160-170	2	200-210	90-120
LAMB	2	160-180	2	200-220	100-120
VENISON	2	175-180	2	200-220	100-120
POULTRY					
Chicken	2	170-180	2	220-250	50-80
Goose(approx.2kg)	2	160-180	2	190-200	150-180
Fish	2	175-180	2	210-220	50-80

Grilling

Take extra precautions when grilling. Intensive heat from infrared element makes the oven and the accessories extremely hot. Use protective gloves and barbecue accessories!

Perforated roast may produce spurting of hot grease (sausages). Use long grill tongs to prevent skin burns and protect your eyes.

Supervise the grill at all time. Excessive heat may quickly burn your food and provoke fire!

Do not let the children in the vicinity of the grill.

Grill heater is especially suitable for the preparation of low-fat sausages, meat and fish fillets and steaks, and for browning and crisping the roast skin.

Tips for grilling

Grilling should be carried out with the oven door closed.

Grilling tables indicate the recommended temperature, guide levels and grilling times, which may vary according to the weight and quality of meat

Grill element should be pre-heated for 3 minutes.

Oil the grill grid before placing food on it, to avoid food sticking to the grid.

Place the meat upon the grid, then place the grid upon the grease interception pan. Insert both trays into the oven guides.

Turn the meat round after half of the grilling time has expired. Thinner slices will require only one turn, for larger chunks you might need to repeat the procedure. Always use barbecue tongs to avoid losing excessive juice from meat.

Dark beef meat is grilled quicker than lighter pork or veal.

Clean the grill, the oven and the accessories each time after use.

Grill table

Type of meat for grill	Weight (in grams)	Guide level (from bottom up)	Temp (°C) 	Grill time (in min.)
Meat and sausages				
2 beefsteaks, rare	400	5	240	14-16
2beefsteaks, medium	400	5	240	16-20
2 beefsteaks, well done	400	5	240	20-23
2 pork scrag fillets	350	5	240	19-23
2 pork chops	400	5	240	20-23
2 veal staeks	700	5	240	19-22
4 lamb cutlets	700	5	240	15-18
4 grill sausages	400	5	240	9-14
2 slices of meat cheese	400	5	240	9-13
1 chicken, halved	1400	3	240-250	28-33(1.side) 23-28(2.side.)
Fish				
Salmon fillets	400	4	240	19-22
Fish in aluminium foil	500	4	230	10-13
Toast				
4 slices of white bread	200	5	240	1,5-3
2 slices of whole meal	200	5	240	2-3
Toast sandwich	600	5	240	4-7
Meat/poultry				
Chicken	1000	3	180-200	60-70
Pork roast	1500	3	160-180	90-120
Pork scrag	1500	3	160-180	100-180
Pork knuckle	1000	3	160-180	120-160
Roast beef/ beef fillet	1500	3	190-200	40-80

TECHNICAL INFORMATION

Model	PPOV-6S-PYRO-2
Voltage rating	220-240V 50Hz
Total power	2.8kW
Top element	800W
Grill element	1000W
Bottom element	1000W
Circular element	1800W