

OVEREASE

Installation and Operating Instructions

Model:
CF688W

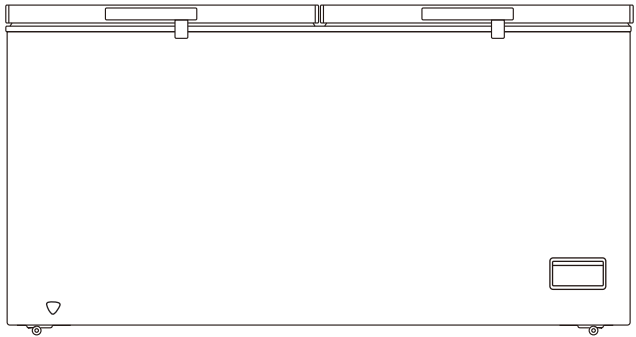

As part of Parmco Appliances commitment to improving and updating product ranges, we reserve the right to alter, change and update technical specifications and appearance attributes of all Parmco Appliances products. E&OE

12062023

PARMCO

Inspiring kitchens, entertaining homes

p: 09 573 5678
f: 09 573 5699
e: sales@parmco.co.nz
w: www.parmco.co.nz

Parmco Appliances extended 7 year warranty



The Warranty:

- This appliance is intended for domestic use in the owners' home. Use of the appliance for commercial purposes will limit the warranty period (please see Parmco website for commercial details).
- Subject to the terms and conditions contained within this warranty, if the product is not of Acceptable Quality (as defined in the Consumer Guarantees Act) within 7 years of the date of original purchase, then Parmco Sales undertakes to repair or, at its sole discretion, replace the product.
- The warranty does not cover the costs of transport, mileage or travelling time if the product is located beyond 30km of a recognised Service Agent.
- This warranty is offered as an extra benefit, and does not affect other legal rights, which can not be modified or excluded by agreement.
- This warranty only applies to goods supplied and installed in the North and South Islands of New Zealand.
- The provisions of this warranty are in addition to the rights and remedies available to consumers under the Consumer Guarantees Act 1993.

The Warranty is not valid:

- If the product is not installed and operated in accordance with the operating instructions.
- If the product is not installed to comply with the electrical, gas, plumbing and other Regulations and Codes of Practice in New Zealand.
- If the product is operated on voltages or frequencies outside the normal range for domestic appliances in New Zealand.
- If the product is not used in normal domestic use, or if it is used in a business as defined in the Consumer Guarantees Act.
- If any serial number has been removed or defaced.
- If proof of date of purchase is not supplied, except at the sole discretion of Parmco Sales. Proof of purchase can be for the product itself, or if installed with a kitchen or house then proof of purchase can be from a Parmco reseller of products supplied by Parmco.
- If the products are purchased in a second hand condition from other parties (including but not limited to TradeMe, Sella, etc.)

Liability under this warranty will not be accepted for:

- Wear and tear caused by normal domestic use of the product.
- Damage in transport.
- Damage caused to the product by neglect, abuse, negligence, wilful act or misuse.
- Any costs associated with the repair, replacement, removal or reinstallation of products installed in a damaged condition.
- Any defect caused by accident, misuse, neglect, tampering with or unauthorised modifications of the appliance or any attempt at internal adjustment or repair by any person other than an Authorised Service Agent.
- Service calls that relate principally to the following:
 - Instruction on how to use the product.
 - Repair or replacement of house fuses, electrical wiring, gas fitting or plumbing.
 - Normal or scheduled maintenance including blocked filters or ducting.
 - Consumable items such as light bulbs.
 - Any damage to hobs caused by spills when cooking.
 - Any breakage or damage of glass items.
 - Any damage caused by non recommended product used for cleaning, maintaining, lubricating or similar.
- Any aspect relating to the installation of the product, or damage caused during installation including blocked access for repair.
- Any third party (including reseller) or consequential loss or damage (direct or indirect) however arising.

Product _____ Date of purchase _____
Serial Number _____
Dealer / Retailers Name _____

Please retain this Warranty card together with receipt or other proof of purchase date when seeking service during the warranty period

Please contact Parmco at 09 573 5678 if your appliance needs servicing under warranty. Please have your model number and proof of purchase ready. Warranty repairs must be authorized by Parmco.

Subject to updates without prior notice, please visit www.parmco.co.nz for the latest version.

100%
NZ OWNED
& OPERATED

EST. 1989

Dear Valued Customer,

Thank you and congratulations on purchasing your new Parmco appliance.

All Parmco products are made to the highest quality and design standards. We are sure you will enjoy your new appliance.

As a note, please read through these instructions carefully. These will assist you in gaining a complete understanding of the functions and features offered by your appliance. Please take special note of all detailed technical information and installation instructions. It is essential that you follow these instructions to ensure the safety and reliability of this appliance.

Furthermore, not using appropriate personnel to install this appliance may affect any future warranty claims lodged, so please check with Parmco Appliances before any installation is carried out.

We hope you enjoy your new appliance. If you would like to find out more about this product or any other products in Parmco's extensive range, visit us online at www.parmco.co.nz.

Regards,

The Parmco Team

P A R M C O

Inspiring kitchens, entertaining homes

Contents

| | |
|-----------------------|-----------|
| 1. Safety Information | Page 1~4 |
| 2. Overview | Page 5 |
| 3. Installation | Page 6~7 |
| 4. Daily Use | Page 8~12 |

Safety information

In the interest of your safety and to ensure the correct use, before installing and first using the appliance, read this user manual carefully, including its hints and warnings. To avoid unnecessary mistakes and accidents, it is important to ensure that all people using the appliance are thoroughly familiar with its operation and safety features. Save these instructions and make sure that they remain with the appliance if it is moved or sold, so that everyone using it through its life will be properly informed on appliance use and safety.

For the safety of life and property keep the precautions of these user's instructions as the manufacturer is not responsible for damages caused by omission.

Children and vulnerable people safety

This appliance can be used by children aged from 8 years and above and persons with reduced physical, sensory or mental capabilities or lack of experience and knowledge if they have been given supervision or instruction concerning use of the appliance in a café and understand the hazards involved.

Children should be supervised to ensure that they do not play with the appliance.

Cleaning and user maintenance shall not be made by children unless they are aged from 8 years and above and supervised.

Keep all packaging well away from children. There is risk of suffocation.

If you are discarding the appliance pull the plug out of the socket, cut the connection cable (as close to the appliance as you can) and remove the door to prevent playing children to suffer electric shock or to close themselves into it.

If this appliance featuring magnetic door seals is to replace an older appliance having a spring lock (latch) on the door or lid, be sure to make that spring lock unusable before you discard the old appliance. This will prevent it from becoming a death trap for a child.

General safety

 **WARNING!** Keep ventilation openings, in the appliance enclosure or in the built-in structure, clear of obstruction.

 **WARNING!** Do not use mechanical devices or other means to accelerate the defrosting process, other than those recommended by the manufacturer.

 **WARNING!** Do not damage the refrigerant circuit.

Safety information

 **WARNING!** Do not use other electrical appliances (such as ice cream makers) inside of refrigerating appliances, unless they are approved for this purpose by the manufacture.

Do not store explosive substances such as aerosol cans with a flammable propellant in this appliance.

The refrigerant isobutane (R290) is contained within the refrigerant circuit of the appliance, a natural gas with a high level of environmental compatibility, which is nevertheless flammable.

During transportation and installation of the appliance, be certain that none of the components of the refrigerant circuit become damaged.

- avoid open flames and sources of ignition
- thoroughly ventilate the room in which the appliance is situated

It is dangerous to alter the specifications or modify this product in any way. Any damage to the cord may cause a short circuit, fire and/or electric shock.

This appliance is intended to be used in household and similar applications such as

- staff kitchen areas in shops, offices and other working environments;
- farm houses and by clients in hotels, motels and other residential type environments;
- bed and breakfast type environments;
- catering and similar non-retail applications.

 **WARNING!** Any electrical components (plug, power cord, compressor and etc.) must be replaced by a certified service agent or qualified service personnel.

Power cord must not be lengthened.

Make sure that the power plug is not squashed or damaged by the back of the appliance. A squashed or damaged power plug may overheat and cause a fire.

Make sure that you can come to the mains plug of the appliance.

Do not pull the mains cable.

If the power plug socket is loose, do not insert the power plug. There is a risk of electric shock or fire.

This appliance is heavy. Care should be taken when moving it.

Do not remove nor touch items from the freezer compartment if you hands are damp/wet, as this could cause skin abrasions or frost/freezer burns.

Avoid prolonged exposure of the appliance to direct sunlight.

Safety information

Daily use

Do not put hot on the plastic parts in the appliance.

Frozen food must not be re-frozen once it has been thawed out.

Store pre-packed frozen food in accordance with the frozen food manufacture's instructions.

Appliance's manufactures storage recommendations should be strictly adhered to. Refer to relevant instructions.

Do not place carbonated or fizzy drinks in the freezer compartment as it creates pressure on the container, which may cause it to explode, resulting in damage to the appliance.

Ice lollies can cause frost burns if consumed straight from the appliance.

Care and cleaning

Before maintenance, switch off the appliance and disconnect the mains plug from the mains socket.

Do not clean the appliance with metal objects.

Do not use sharp objects to remove frost from the appliance. Use a plastic scraper.

Regularly examine the drain in the chest freezer for defrosted water. If necessary, clean the drain.

Installation

Important! For electrical connection carefully follow the instructions given in specific paragraphs.

Unpack the appliance and check if there are damages on it. Do not connect the appliance if it is damaged. Report possible damages immediately to the place you bought it. In that case retain packing.

It is advisable to wait at least four hours before connecting the appliance to allow the oil to flow back in the compressor.

Adequate air circulation should be around the appliance, lacking this leads to overheating. To achieve sufficient ventilation follow the instructions relevant to installation.

Wherever possible the spacers of the product should be against a wall to avoid touching or catching warm parts (compressor, condenser) to prevent possible burn.

The appliance must not be located close to radiators or cookers.

Make sure that the mains plug is accessible after the installation of the appliance.

Safety information

Service

Any electrical work required to do the servicing of the appliance should be carried out by a qualified electrician or competent person. This product must be serviced by an authorized Service Center, and only genuine spare parts must be used.

Energy saving

Don't put hot food in the appliance;
Don't pack food close together as this prevents air circulating;
Make sure food don't touch the back of the compartment(s);
If electricity goes off, don't open the door(s);
Don't open the door(s) frequently;
Don't keep the door(s) open for too long time;
Don't set the thermostat on exceeding cold temperatures;
Some accessories, such as drawers, can be removed to get larger storage volume and lower energy consumption.

Environment Protection

 This appliance does not contain gasses which could damage the ozone layer, in either its refrigerant circuit or insulation materials. The appliance shall not be discarded together with the urban refuse and rubbish. The insulation foam contains flammable gases: the appliance shall be disposed according to the appliance regulations to obtain from your local authorities. Avoid damaging the cooling unit, especially the heat exchanger. The materials used on this appliance marked by the symbol ♻ are recyclable.

The symbol  on the product or on its packaging indicates that this product may not be treated as household waste. Instead it should be taken to the appropriate collection point for the recycling of electrical and electronic equipment. By ensuring this product is disposed of correctly, you will help prevent potential negative consequences for the environment and human health, which could otherwise be caused by inappropriate waste handling of this product. For more detailed information about recycling of this product, please contact your local council, your household waste disposal service or the shop where you purchased the product.

Packaging materials

The materials with the symbol are recyclable. Dispose the packaging in a suitable collection containers to recycle it.

Disposal of the appliance

1. Disconnect the mains plug from the mains socket.
2. Cut off the mains cable and discard it.

Overview

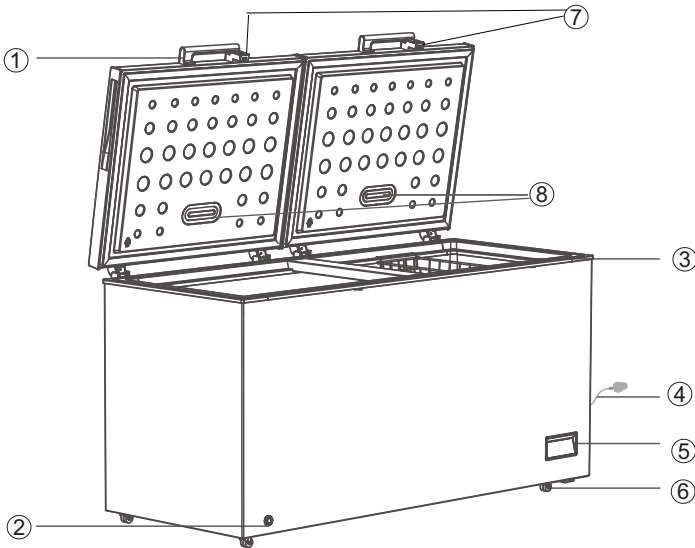

- 1. External Handle
- 2. Drain Hole
- 3. Basket
- 4. Power Cord
- 5. Thermostat control panel
- 6. Wheel
- 7. Lock
- 8. LED lamp

Note: Above picture is for reference only.

Installation

Install door external handle (if external handle is present)

Step1

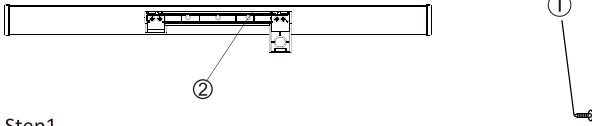

Step1

Take out 4 screws ① and handle base ② from accessory bag. Then fix the handle base ② with door by 4 screws ①.

Step2

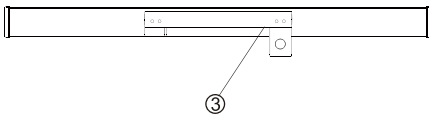

Step2

Insert handle cover ③ in the handle base ② until a click.

Step 3

After handle cover assembled on the door , fasten the handle decorated cover ④ on the handle cover. Please refer to the attached photo.

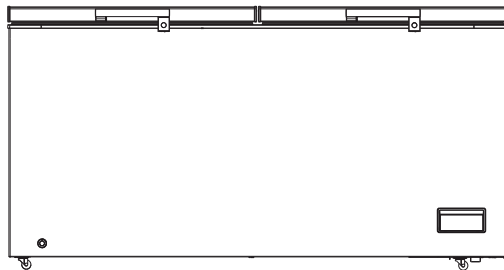
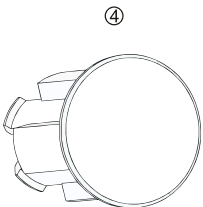

Installation

Space Requirement

The following are recommended.
Clearances around the chest freezer
Sides.....10cm
Back10cm
Top70cm

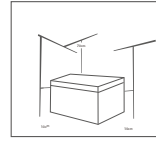

Positioning

Install this appliance at a location where the ambient temperature corresponds to the climate class indicated on the rating plate of the appliance:

| Climate class | Ambient temperature |
|---------------|---------------------|
| SN | +10°C to +32°C |
| N | +16°C to +32°C |
| ST | +16°C to +38°C |
| T | +16°C to +43°C |

Location

The appliance should be installed well away from sources of heat such as radiators, boilers, direct sunlight etc. Ensure that air can circulate freely around the back of the cabinet. To ensure best performance, if the appliance is positioned below an overhanging wall unit, the minimum distance between the top of the cabinet and the wall unit must be at least 100 mm. Ideally, however, the appliance should not be positioned below overhanging wall units. Accurate leveling is ensured by one or more adjust-able feet at the base of the cabinet.

Warning! It must be possible to disconnect the appliance from the mains power supply; the plug must therefore be easily accessible after installation.

Electronical connection

Before plugging in, ensure that the voltage and frequency shown on the rating plate correspond to your domestic power supply. The appliance must be earthed. The power supply cable plug is provided with a contact for this purpose. If the domestic power supply socket is not earthed, connect the appliance to a separate earth in compliance with current regulations, consulting a qualified electrician. The manufacturer declines all responsibility if the above safety precautions are not observed. This appliance complies with the E. E. C. Directives.

Daily Use

First use

Cleaning the interior

Before using the appliance for the first time, wash the interior and all internal accessories with lukewarm water and some neutral soap so as to remove the typical smell of a brand new product, then dry thoroughly.

Important! Do not use detergents or abrasive powders, as these will damage the finish.

Temperature Setting

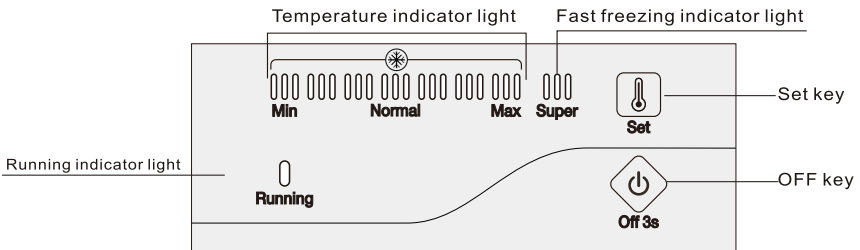

1.0 Electrical connection

When the appliance is plugged in, all LED indicator lights will flash once. Then the appliance will resume the mode previously set before the electrical outage.

2.0 Temperature Setting

- **Setting:** Press “SET” button, enter the temperature setting mode. The temperature indicator bar of temperature goes up a scale by each press. This setting runs in cycles. Temperature can run from Scale MIN to Scale MAX. Scale MAX is the coldest. The temperature is automatically set in 5 seconds after last press.
- **Super Freezing**
 - ✓ Press “SET” button consecutively to enter “SUPER” freezing mode from Scale MAX, the indicator bar on the left hereby will turn dark whereas the indicator light of “SUPER” turns on. This mode is automatically set in 5 seconds after last press.
 - ✓ The compressor keeps working in “SUPER” freezing mode.
 - ✓ If the “SUPER” mode keeps running for 52 hours and not stopped manually, the system will automatically cut out this mode, with the temperature back at Scale 5.

2.1 Power On & Power Off

If the appliance is working, press “ON/OFF” for 3 seconds to turn off.

If the appliance is off, press “ON/OFF” for 3 seconds to turn on.

Daily Use

3.0 Indicator Lights

- Temperature Indicator Light (Bright Blue): To adjust the temperature from Scale MIN to Scale MAX. MAX is the coldest.
- Super Freezing Indicator Light (Bright Blue): Light on = in "SUPER" mode; light off = exit "SUPER" mode.
- Running Indicator Light (Bright Green): Light on = compressor in work; light off = compressor stops.
- 30 minutes after the last operation, the indicator light will be on in half luminance.

4.0 Resumption Function

The appliance will automatically resume the mode previously set before the electrical outage.

5.0 Temperature Sensor Fault Alarm

When there is a disconnection or short out of the temperature sensor, as a fault alarm, the temperature indicator bar will flash from left to right every 0.5 second.

Daily use

Freezing fresh food

- The freezer compartment is suitable for freezing fresh food and storing frozen and deep-frozen food for a long time.
- Place the fresh food to be frozen in the bottom compartment.
- The maximum amount of food that can be frozen in 24 hours is specified on the rating plate.
- The freezing process lasts 24 hours: during this period do not add other food to be frozen.

Storing frozen food

When first starting-up or after a period out of use. Before putting the product in the compartment let the appliance run at least 2 hours on the higher settings.

Important! In the event of accidental defrosting, for example the power has been off for longer than the value shown in the technical characteristics chart under "rising time", the defrosted food must be consumed quickly or cooked immediately and then re-frozen (after cooked).

Thawing

Deep-frozen or frozen food, prior to be used, can be thawed in a fridge compartment or at room temperature, depending on the time available for this operation.

Small pieces may even be cooked still frozen, directly from the freezer. In this case, cooking will take longer.

Helpful hints and tips

Hints for freezing

To help you make the most of the freezing process, here are some important hints:

- the maximum quantity of food which can be frozen in 24 hrs. is shown on the rating plate;
- the freezing process takes 24 hours. No further food to be frozen should be added during this period;
- only freeze top quality, fresh and thoroughly cleaned, foodstuffs;
- prepare food in small portions to enable it to be rapidly and completely frozen and to make it possible subsequently to thaw only the quantity required;
- wrap up the food in aluminium foil or polythene and make sure that the packages are airtight;
- do not allow fresh, unfrozen food to touch food which is already frozen, thus avoiding a rise in temperature of the latter;

Daily Use

- lean foods store better and longer than fatty ones; salt reduces the storage life of food;
- water ices, if consumed immediately after removal from the freezer compartment, can possibly cause the skin to be freeze burnt;
- it is advisable to show the freezing in date on each individual pack to enable you removal from the freezer compartment, can possibly cause the skin to be freeze burnt;
- it is advisable to show the freezing in date on each individual pack to enable you to keep tab of the storage time.

Hints for storage of frozen food

To obtain the best performance from this appliance, you should:

- make sure that the commercially frozen foodstuffs were adequately stored by the retailer;
- be sure that frozen foodstuffs are transferred from the food store to the freezer in the shortest possible time;
- not open the door frequently or leave it open longer than absolutely necessary.
- Once defrosted, food deteriorates rapidly and cannot be refrozen.
- Do not exceed the storage period indicated by the food manufacture.

Cleaning

For hygienic reasons the appliance interior, including interior accessories, should be cleaned regularly.

 **Caution!** The appliance may not be connected to the mains during cleaning. Danger of electrical shock! Before cleaning switch the appliance off and remove the plug from the mains, or switch off or turn out the circuit breaker or fuse. Never clean the appliance with a steam cleaner. Moisture could accumulate in electrical components, danger of electrical shock! Hot vapors can lead to the damage of plastic parts. The appliance must be dry before it is placed back into service.

Important! Ethereal oils and organic solvents can attack plastic parts, e.g. lemon juice or the juice from orange peel, butyric acid, cleanser that contain acetic acid.

- Do not allow such substances to come into contact the appliance parts.
- Do not use any abrasive cleaners
- Remove the food from the freezer. Store them in a cool place, well covered.
- Switch the appliance off and remove the plug from the mains, or switch off or turn out the circuit breaker of fuse.
- Clean the appliance and the interior accessories with a cloth and lukewarm water. After cleaning wipe with fresh water and rub dry.
- Accumulation of dust at the condenser increases energy consumption. For this reason carefully clean the condenser at the back of the appliance once a year with a soft brush or a vacuum cleaner.¹⁾
- After everything is dry place appliance back into service.

Defrosting of the freezer

The freezer, however, will become progressively covered with frost. This should be removed.

Never use sharp metal tools to scrape off frost from the evaporator as you could damage it.

However, when the ice becomes very thick on the inner liner, complete defrosting should be carried out as follows:

- Unplug the unit. Remove the drain plug from the inside of the freezer. Defrosting usually takes a few hours. To defrost faster keep the freezer door open.
- For draining, place a tray beneath the outer drain plug. Pull out the drain dial.



- Rotate the drain dial 180 degree. This will let the water flow out in the tray. When done, push the drain dial in. Replug the drain plug inside the freezer compartment. Note: monitor the container under the drain to avoid overflow.
- Wipe the interior of the freezer and replace the electrical plug in the electrical outlet.
- Reset the temperature control to the desired setting.



1) If the condenser is at back of appliance.

Daily Use

Troubleshooting



Caution! Before troubleshooting, disconnect the power supply. Only a qualified electrician of competent person must do the troubleshooting that is not in this manual.

Important! There are some sounds during normal use (compressor, refrigerant circulation).

| Problem | Possible cause | Solution |
|---|---|--|
| Appliance dose not work | Mains plug is not plugged in or is loose | Insert mains plug. |
| | Fuse has blown or is defective | Check fuse, replace if necessary. |
| | Socket is defective | Mains malfunctions are to be corrected by an electrician. |
| Appliance freezes too much | Temperature is set too cold or the appliance runs at MAX setting. | Turn the temperature regulator to a warmer setting temporarily. |
| The food is not frozen enough. | Temperature is not properly adjusted. | Please look in the initial Temperature Setting section. |
| | Door was open for an extended period. | Open the door only as long as necessary. |
| | A large quantity of warm food was placed in the appliance within the last 24 hours. | Turn the temperature regulation to a colder setting temporarily. |
| | The appliance is near a heat source. | Please look in the installation location section. |
| Heavy build-up of frost on the door seal. | Door seal is not air-tight. | Carefully warm the leaking sections of the door seal with a hair dryer (on a cool setting). At the same time shape the warmed door seal by hand such that it sits correctly. |
| Unusual noises | The appliance is touching the wall or other objects. | Move the appliance slightly. |
| | A component, e.g. a pipe, on the rear of the appliance is touching another part of the appliance or the wall. | If necessary, carefully bend the component out of the way. |

If the malfunction shows again, contact the Service Center.

These data are necessary to help you quickly and correctly. Write the necessary data here, refer to the rating plate.

Replace the lamp

The switch of LED lamp is gravity controlled, when the angle of door-opening is bigger than 30. Degree, light will switch on and switch off when the angle is smaller than 30 degree.

Notice:

When LED lamp does not work when door is open, Please be released and check as below steps:

- Firstly, loosen screws on the lamp cover
- Secondly, loosen the screws fixed on the lamp electronic parts

Daily Use

- Thirdly, check the cable terminals of electronic parts and terminals of contacting lines for door lamp is loosening or not. Please fix them if they are not fixed. Then, check the light is on or not. If the lamp is switch on please install the lamp cover; if not, please further check the electronic part is intact or not. If necessary, please replace the electronic part to check the lamp is on or not. If the lamp still does not work. Please contact with staff of after-sale service for assistance.
- The steps of LED lamp installing
 - Fix the cable terminals of electronic parts and contacting lines in the door liner;
 - Install LED electronic part in the door liner and fix on by screws;
 - Install lamp cover on the holder and fix to finish all process

R290 Refrigerant Warning

- This appliance contains a small quantity of R290 refrigerant which is environmentally friendly, but flammable. It does not damage the ozone layer, nor does it increase the greenhouse effect.
- During transportation and installation, ensure that the tubing of the refrigerant circuit is not damaged.
- Leaking refrigerant can ignite and may damage the eyes.
- In the event any damage does occur, avoid exposure to open fires and any device which creates a spark. Disconnect the appliance from the mains power.
- Thoroughly ventilate the room in which the appliance is located for several minutes.
- The room for installing the appliance must be at least 1 cubic metre over 8 grams of refrigerant. The refrigerant quantity contained in this appliance is noted on the Rating Plate of the appliance.
- It is hazardous for anyone other than an Authorised Service Person to service this appliance. In Queensland – the authorised Service Person MUST hold a Gas Work Authorisation for hydrocarbon refrigerants, to carry out Servicing or repairs which involve the removal of covers.