

PARMCO

# Installation and Operating Instructions

**Models:**

**DR7WCON**

**DR7WHP**

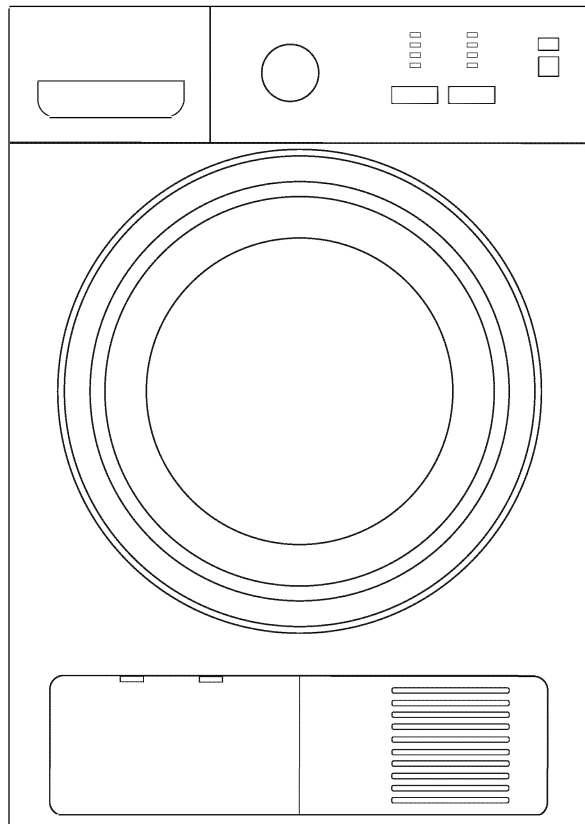

As part of Parmco Appliances commitment to improving and updating product ranges, we reserve the right to alter, change and update technical specifications and appearance attributes of all Parmco Appliances products. E&OE.

## *Parmco Appliances extended 7 year warranty*



### **The Warranty:**

- Subject to the terms and conditions contained within this warranty, if the product is not of Acceptable Quality (as defined in the Consumer Guarantees Act) within 2 years of the date of original purchase, then Parmco Sales undertakes to repair or, at its sole discretion, replace the product.
- The warranty does not cover the costs of transport, mileage or travelling time if the product is located beyond 30km of a recognised Service Agent.
- This warranty is offered as an extra benefit, and does not affect other legal rights, which can not be modified or excluded by agreement.
- This warranty only applies to goods supplied and installed in the North and South Islands of New Zealand.
- The provisions of this warranty are in addition to the rights and remedies available to consumers under the Consumer Guarantees Act 1993.
- Products purchased as seconds or thirds may or may not carry a warranty. Please check with your reseller at the time of purchase for the warranty period being offered.

### **The Warranty is not valid:**

- If the product is not installed and operated in accordance with the operating instructions.
- If the product is not installed to comply with the electrical, gas, plumbing and other Regulations and Codes of Practice in New Zealand.
- If the product is operated on voltages or frequencies outside the normal range for domestic appliances in New Zealand.
- If the product is not used in normal domestic use, or if it is used in a business as defined in the Consumer Guarantees Act.
- If any serial number has been removed or defaced.
- If proof of date of purchase is not supplied, except at the sole discretion of Parmco Sales. Proof of purchase can be for the product itself, or if installed with a kitchen or house then proof of purchase can be from a Parmco reseller of products supplied by Parmco.
- If the products are purchased in a second hand condition from other parties (including but not limited to TradeMe, Sella, etc.)

### **Liability under this warranty will not be accepted for:**

- Wear and tear from normal domestic use.
- Damage in transport.
- Damage caused to the product by neglect, abuse, negligence, wilful act or misuse.
- Any costs associated with the repair, replacement, removal or reinstallation of products installed in a damaged condition.
- Any defect caused by accident, misuse, neglect, tampering with or unauthorised modifications of the appliance or any attempt at internal adjustment or repair by any person other than an Authorised Service Agent.
- Service calls that relate principally to the following:
  - Instruction on how to use the product.
  - Repair or replacement of house fuses, electrical wiring, gas fitting or plumbing.
- Wear and tear caused by normal use of the product.
- Normal or scheduled maintenance including blocked filters or ducting.
- Consumable items such as light bulbs.
- Any damage to hobs caused by spills when cooking.
- Any breakage or damage of glass items.
- Any damage caused by non recommended product used for cleaning, maintaining, lubricating or similar.
- Any aspect relating to the installation of the product, or damage caused during installation including blocked access for repair.
- Any third party (including reseller) or consequential loss or damage (direct or indirect) however arising.

Product \_\_\_\_\_ Date of purchase \_\_\_\_\_

Dealer / Retailers Name \_\_\_\_\_

Please retain this Warranty card together with receipt or other proof of purchase date when seeking service during the warranty period

Please contact Parmco at 09 573 5678 if your appliance needs servicing under warranty. Please have your model number and proof of purchase ready. Warranty repairs must be authorized by Parmco.

Dear Valued Customer,

Thank you and congratulations on purchasing your new Parmco appliance.

All Parmco products are made to the highest quality and design standards. We are sure you will enjoy your new appliance.

As a note, please read through these instructions carefully. These will assist you in gaining a complete understanding of the functions and features offered by your appliance. Please take special note of all detailed technical information and installation instructions. It is essential that you follow these instructions to ensure the safety and reliability of this appliance.

Furthermore, not using appropriate personnel to install this appliance may affect any future warranty claims lodged, so please check with Parmco Appliances before any installation is carried out.

We hope you enjoy your new appliance. If you would like to find out more about this product or any other products in Parmco's extensive range, visit us online at [www.parmco.co.nz](http://www.parmco.co.nz).

Regards,  
**The Parmco Team**

**P A R M C O**

Inspiring kitchens, entertaining homes

# CONTENTS

---

## SAFETY INSTRUCTIONS

- Safety Instructions ..... 2

## INSTALLATION

- Product Description ..... 7
- Installation ..... 7

## OPERATIONS

- Quick Start ..... 9
- Before Each Drying ..... 10
- Control Panel ..... 12
- Other Functions..... 13
- Drying Programmes Table ..... 15

## MAINTENANCE

- Cleaning And Care ..... 16
- Trouble Shooting ..... 18
- Technical Specifications ..... 20

# SAFETY INSTRUCTIONS

---

## ■ Safety Instructions

### ⚠ Warning!

To prevent any damages to your and others' life or property, you have to follow the safety notes.

- This product belongs to Category I electrical appliances, and only for drying textiles which have been washed with water in the household. Please pay attention to the safety of power use during the operation!
- The power source with reliable earthing must be used. Its earth wire must be buried under the ground and shall not be connected with the public utilities such as city water pipe or gas pipe etc. The earth wire and null wire shall be distinguished and shall not be connected together.
- The power wire shall be met IEC and must be able to withstand the current above 10A. To ensure your and your family's safety, please make improvement immediately if any power use at your home does not meet the above-mentioned requirements.
- Do not put more load than recommended. Obey the maximum load volume. See the related chapter in the user manual.
- That the tumble dryer is not to be used if industrial chemicals have been used for cleaning.
- Do not dry unwashed items in the tumble dryer.
- Items that have been soiled with substances such as cooking oil, acetone, alcohol, petrol, kerosene, spot removers, turpentine, waxes and wax removers should be washed in hot water with an extra amount of detergent before being dried in the tumble dryer.
- Items such as foam rubber (latex foam), shower caps, waterproof textiles, rubber backed articles and clothes or pillows fitted with foam rubber pads should not be dried in the tumble dryer.
- Fabric softeners, or similar products, should be used as specified by the fabric softener instructions.

## SAFETY INSTRUCTIONS

---

- The final part of a tumble dryer cycle occurs without heat (cool down cycle) to ensure that the items are left at a temperature that ensures that the items will not be damaged.
- The lint trap has to be cleaned frequently.
- The lint must not to be allowed to accumulate around the tumble dryer.
- Adequate ventilation has to be provided to avoid the back flow of gases into the room from appliance burning other fuels, including open fires.
- The exhaust air must not be discharged into a flue which is used for exhausting fumes from appliance burning gas or other fuels.
- The appliance must not be install behind a lockable door, a sliding door or a door with a hinge on the opposite side to that of the tumble dryer. In such a way that a full opening of the tumble dryer door is restricted.
- Oil-affected items can ignite spontaneously, especially when exposed to heat sources such as in a tumble dryer. The items become warm, causing an oxidation reaction in the oil. Oxidation creates heat. If the heat cannot escape, the items can become hot enough to catch fire. Piling, stacking or storing oil-affected items can prevent heat from escaping and so create a fire hazard.
- If it is unavoidable that fabrics that contain vegetable or cooking oil or have been contaminated by hair care products be placed in a tumble dryer they should first be washed in hot water with extra detergent-this will reduce, but not eliminate, the hazard.
- The appliance should not be overturned during normal use or maintenance.
- Remove all objects from pockets such as lighters and matches.
- This appliance can be used by children aged from 8 years and above and persons with reduced physical, sensory or mental capabilities or lack of experience and knowledge if

## SAFETY INSTRUCTIONS

---

they have been given supervision or instruction concerning use of the appliance in a safe way and understand the hazards involved. Children shall not play with the appliance. Cleaning and user maintenance shall not be made by children without supervision. (This warning is only for EUROPEAN market)

- If the power cable is damaged, it must be replaced by the manufacturer, its service agent or similarly qualified persons in order to avoid a hazard.
- This appliance is for indoor use only.
- The openings must not be obstructed by a carpet.
- Children of less than 3 years should be kept away unless continuously supervised.
- If the appliance appears high temperature abnormally, please draw the mail plug immediately.
- The appliance is not intended for use by persons (including children) with reduced physical, sensory or mental capabilities, or lack of experience and knowledge, unless they have been given supervision or instruction concerning use of the appliance by a person responsible for their safety. Children should be supervised to ensure that they do not play with the appliance. (This warning is not for EUROPEAN market)
- The power wire shall be met IEC and must be able to withstand the current as the below table.  
To ensure your and your family's safety, please make improvement immediately if any power use at your home does not meet the above-mentioned requirement.

Model	Current
DR7WHP	10A
DR7WCON	16A

## SAFETY INSTRUCTIONS

### **⚠ Warning!**

Never stop a tumble dryer before the end of the drying cycle otherwise too much heat will diffuse and may cause harm.

### **⚠ Warning!**

The appliance must not be supplied through an external switching device, such as a timer, or connected to a circuit that is regularly switched on and off by a utility.

Correct Disposal of this product:



This marking indicates that this product should not be disposed with other household wastes throughout the EU. To prevent possible harm to the environment or human health from uncontrolled waste disposal, recycle it responsibly to promote the sustainable reuse of material resources. To return your used device, please use the return and collection systems or contact the retailer where the product was purchased. They can take this product for environmental safe recycling.

## SAFETY INSTRUCTIONS

### **Electric shock hazard**

- Do not draw the power cord forcefully to pull out the mains plug.
- Please do not plug/draw the mains plug with wet hands.
- Do not damage the power cord and the power plug.

### **Injury danger**

- Do not disassemble and install the dryer under no instruction or supervision.
- Do not stack this dryer on washing machine without stacking kits.(if want stacking on washing machine, please purchase the independent parts and it must be installed by the manufacturer, its service agent or similarly qualified persons in order to avoid a hazard.)
- Do not lean on the opened door of the dryer.
- Do not put any pyrotoxin on the dryer, such as the candle, electric cooker.

### **Damage danger**

- Do not dry over the rated capacity.
- Do not operate the dryer without the filter door and filter base.
- Do not dry the clothes before being spun.
- Do not expose the dryer directly under the sun, and indoor use only.
- Do not install the dryer in humid and drenching environment.
- While cleaning and maintenance, please do remember to pull out the power plug and do not directly wash the dryer with water.

### **Explosion danger**

Please do not dry the clothes with some flammable substances such as coal oil, alcohol or there will be explosion.

# INSTALLATION

## ■ Product Description

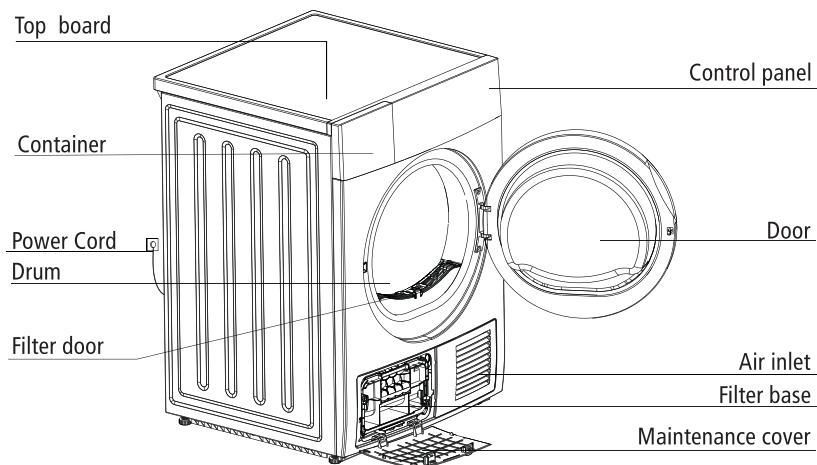

## Accessories

The following parts are optional for specific models. If your dryer has following parts, please wear gloves and install them following the instruction below .

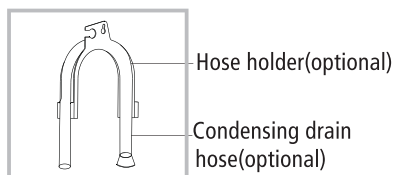

## ■ Installation

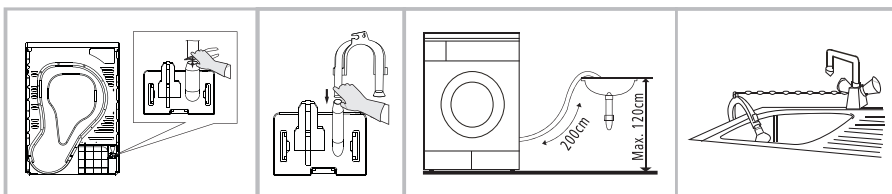

Use pliers to remove the drain hose from the hose connector.

Insert the external drainage hose.

Put the hose holder on the washing basin or any other sink.

# INSTALLATION

## Transport

Move cautiously. Do not grasp any salient parts of machine. The machine door can not be used as the handle for delivery. If the dryer can't be transported erectly, the dryer could be slant to right less than 30°.

## Installation Position

1. It is recommended that, for your convenience, the machine is positioned close to your washing machine.
2. The tumble dryer must be installed in a clean place, where dirt does not build up. Air must be able to circulate freely all round the appliance. Do not obstruct the front air inlet or the air intake grilles at the back of the machine.
3. To keep vibration and noise to a minimum when the dryer is in use, it should be placed on a firm and level surface.
4. The feet must never be removed. Do not restrict the floor clearance through deep pile carpets, strips of wood or similar. This might cause heat built-up which would interfere with the operation of the appliance.

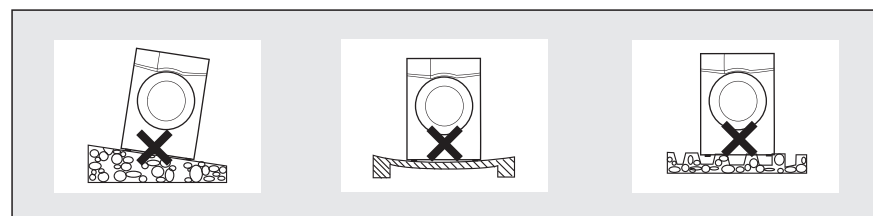

## Level Adjusting

Once in its permanent operating position, check that the dryer is absolutely level with the aid of a spirit level. If it is not, adjust the feet with a tool.

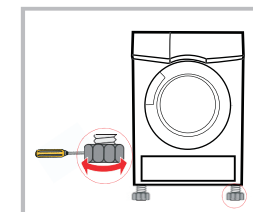

## Power Supply Connection

1. Make sure that the voltage of the power supply is the same as the electric specification of the dryer.
2. Do not connect the dryer with the power connection board, the universal plug or socket.

# OPERATIONS

## ■ Quick Start

### 📌 Note!

Before using, please make sure it's installed properly.

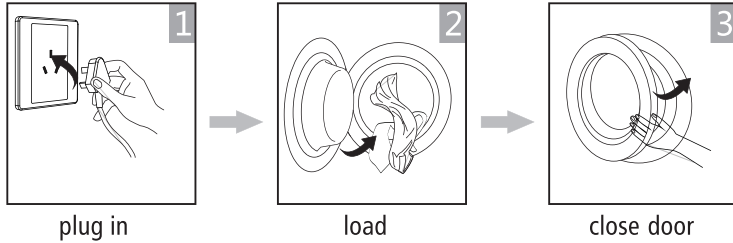

## Drying

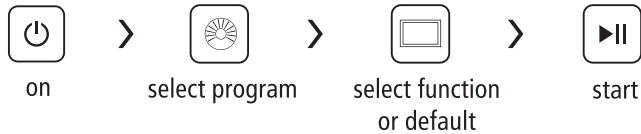

## After Drying

Buzzer beep or "0:00" on display.

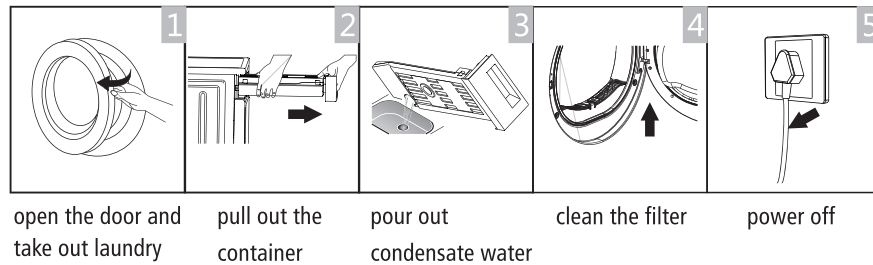

### 📌 Note!

- If use the socket with a switch, please press the switch to turn off the power directly.

# OPERATIONS

## ■ Before Each Drying

### 📌 Note!

- Leave it to stand for 2 hours after transporting. Before first use, please use the soft fabric to clean the inside drum..
  1. Put some clean rags into the drum.
  2. Plug the power, press 【On/Off】.
  3. Select the 【Refresh】 Programme, press 【Start/Pause】 button.
  4. After finishing this programme, please follow the "Cleaning And Care" (refer to page 18) to clean the filter door.
- During drying, the compressor and the water pump generate some noise which is entirely normal(Only MDS70-CH05/B08-AU(6)).

1. Before drying, thoroughly spin the laundry in washing machine. High spin speed can reduce the drying time and save energy consumption.
2. For uniform drying result, sort the laundry according to fabric type and drying programme.
3. Before drying, please close zips, hooks and eyelets, button up, tie fabric belts, etc.
4. Do not over dry the clothes, because over dried clothes can easily get creases.
5. Do not dry the articles containing rubber or similar elastic materials.
6. The door can be opened only after the programme of the drying machine finishes to prevent human skin from being scalded by hot steam or over heated drying machine.
7. Clean the lint filter and empty container after each use to avoid extension of drying time and energy consumption.
8. Do not dry these clothes after dry-clean process.
9. Please choose the related programme when deal with wool material clothes, to make the cloth more fresh and fluffy.

The reference weight of dry clothes (each)

Mixed-fabric clothes (about 800g)	Jacket (about 800g cotton)	Jeans (about 800g)	Towel quilt (about 900g cotton)
Single bedsheet (about 600g cotton)	Work clothes (about 1120g)	Sleepwear (about 200g)	Long sleeve shirt (about 300g cotton)
Short sleeve shirt (about 180g cotton)	Short pants (about 70g cotton)	Socks (about 50g mixed-weave)	













### 📌 Note!

- Never overload.
- Not for textile with dropping water. The dryer could be damaged, even fire.



# OPERATIONS

Please pay attention to use the drying machine if the materials of your clothes can not be dried by it or contain the symbols as follows:

 Dry	 Normal	 Not tumble dry normal	 Do not dry
 Line dry / hang to dry	 Drip dry	 Dry flat	 In the shade
 Dry clean	 Do not dry clean	 Dry clean normal cycle with any solvent	 Dry clean normal cycle petroleum solvent only

# OPERATIONS

## Control Panel

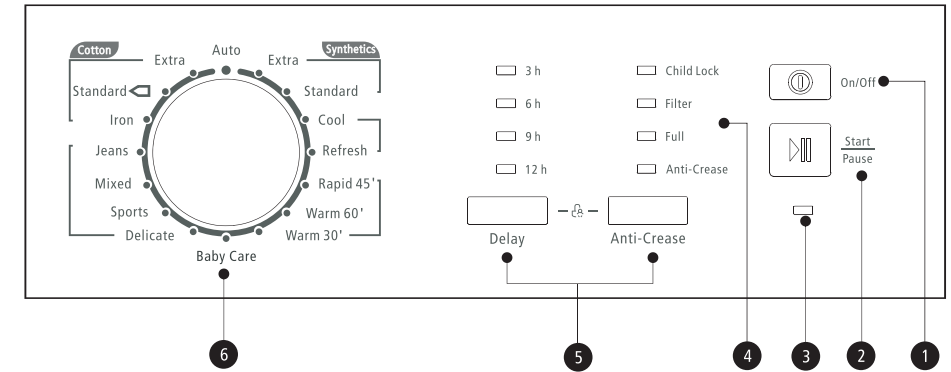

**1 On/Off**  
Product is switched on or off.

**2 Start/Pause**  
Press the button to start or pause the drying cycle.

**3 Working state LED**

**4 Function LED**  
3h, 6h, 9h, 12h, Child lock, Filter, Full and Anti-Crease

**5 Specialty function**  
These buttons are used for setting additional functions ( Delay, Anti-Crease, Childlock ).

**6 Programmes**  
Different Dryer cycle can be selected according to the user's needs to make the clothes have more effective drying result.

# OPERATIONS

---

## Programme selector

1. Press the **【On/Off】** button. When the LED display screen brightens up, rotate the programme knob to select the desired programme.
2. Select the **【Delay】** or **【Anti-Crease】** functions for additional option.
3. Press the **【Start/Pause】** key.

## Programme start

The drum will keep rotating after the programme starts, the state light in the display area will flash in sequence, the remaining time displayed will change automatically.

## Programme end

1. The drum will stop running after the programme ends, the working state LED will stay light and buzzer will ring. The “Filter” and “Full” LED will remind user to clean the filters and container. The dryer will start **【Anti-crease】** function if user doesn't remove the load in time (refer to page 15). Please press **【On/Off】** key to cut off power and pull the plug out.
2. Deal with the problems according to “Malfunction display and solutions”, if there is an unexpected stop during the drying procedure and the dryer shows information (refer to page 18).

## ■ Other Functions

### • Instructions of the **【Delay】** function

To delay the drying programme after 3h, 6h, 9h or 12h.

When the delay programme starts, the time starts to decrease and the LED light.

Steps in details:

1. Load your laundry and make sure the machine door is closed.
2. Press the **【On/Off】** button, then to turn the programme selector knob and select a desired programme.
3. You can select the **【Anti-Crease】** functions according to your need.
4. To press the **【Delay】** key.
5. Continue to press the **【Delay】** to select the delay time.
6. After the **【Start/Pause】** key is pushed, the Dryer is at the run condition.  
The drying procedure will be automatically performed when the delay time is over.
7. If you push the **【Start/Pause】** button again, the delay function will be paused.
8. If you want to cancel the “Delay” function, please press the **【On/Off】** button.

# OPERATIONS

---

### • Instructions of the **【Anti-Crease】** function

At the end of the drying cycle, the anti-crease phase time is 30 minutes (default) or 120 minutes (selected).

This function prevents the laundry from creases. The laundry can be removed during the anti-crease phase. Except **【Cool】**, **【Refresh】**, **【Warm 30'】** and **【Warm 60'】** all the other programmes have this function.

### • Instructions of the **【Child Lock】** function

1. This machine incorporates a special child safety lock, which can prevent children from carelessly pressing keys or making the faulty operation.
2. When the dryer is at the operation state, press the **【Anti-Crease】** and **【Delay】** buttons at the same time for over 3 seconds to start child lock function. When child lock function is set, the display will show Child lock icon and no key can effect to the dryer except **【On/Off】** button. Under the start state of the child lock, the **【Anti-Crease】** and **【Delay】** buttons shall be pressed at the same time for over 3 seconds to release the child lock function.

# OPERATIONS

## ■ Drying Programmes Table

Programme		Weight (max)	Application/Properties
Auto	Auto	5.0kg	To dry unknown material clothes automatically.
Cotton	For cottons and coloureds made of cotton or linen.		
	Extra	7.0kg	To dry cotton pieces of clothing. Drying level: extra dry.
	Standard	7.0kg	To dry cotton pieces of clothing. Drying level: cupboard dry.
	Iron	7.0kg	To dry cotton pieces of clothing. Drying level: applicable to iron.
Jeans	Jeans	5.0kg	To dry jeans or leisure clothes that are spun at high speeds in the washing machine.
Mixed	Mixed	3.5kg	If you can not determine what the clothing's material is, please choose Mix.
Sports	Sports	3.0kg	To dry sportswear, thin fabrics, polyester, which are not ironed.
Delicate	Delicate	1.0kg	To dry delicate laundry that is suitable for drying or laundry which is advised to be hand-washed at a lower temperature.
Baby Care	Baby Care	1.0kg	To dry small amount of baby clothing.
Synthetics	For non-iron washing made of synthetic and blended fabrics, cotton.		
	Extra	3.5kg	To dry thick or multi-layered synthetic fabrics. Drying level: extra dry.
	Standard	3.5kg	To dry thin synthetic fabrics which are not ironed, such as easy care shirts, table linen, baby clothes, socks.
Cool	Cool	—	To air clothes without blowing hot air from in 10 min.
Refresh	Refresh	—	To refresh the clothes that have been kept at closed environments for a long time from minimum 20 min. to maximum 150 min. (in 10 min. steps).
Rapid 45'	Rapid 45'	0.6kg	To dry at most 3 shirts in 45 min.
Warm 60'	Warm 60'	—	To warm clothes with hot air in 60 min.
Warm 30'	Warm 30'	—	To warm clothes with hot air in 30 min.

### 📌 Note!

- ◻ This symbol means the energy efficiency test programme "standard cotton programme", which is accordance with the applicable EN 61121 standard and most suitable to dry normal cotton load at rated load capacity.
- Thick or multi-layered fabrics, e.g. bedlinen, jeans, jackets etc, are not easy to dry. You'd better choose Cotton Extra programme.
- As the uneven material, thick and multi-layered clothes are not easy to dry, it is better to choose the appropriate time drying programme to dry them if some parts of the clothes still damp after programme finished.

# MAINTENANCE

## ■ Cleaning And Care

### Empty the water container

1. Hold and pull out the water container with two hands.
2. Tilt the water container, pour out the condensate water into basin.
3. Install the water container.

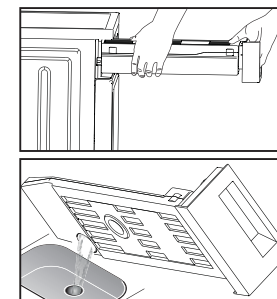

### ⚠ Warning!

- Empty the water container after each use, the programme will be paused and the Full LED icon will light if the water container is full during the drying process. After the container is emptied, the dryer can be restarted by pressing **【Start/Pause】** button.
- Do not drink the condensate water.
- Do not use the dryer without the water container.

### Clean the filter door

1. Open the door.
2. Take out the filter door.
3. Clean the filter door; wipe off the scrap threads accumulated on the filter door.
4. Reinstall the filter door.

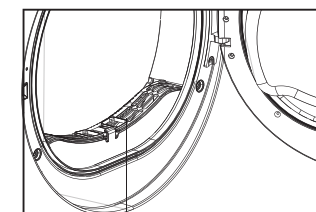

Filter door

### Clean filter base (Only MDS70-CH05/B08-AU(6))

1. Open the cover.
2. Unscrew both locking levers towards each other.
3. Clean the filter base completely.
4. Re-insert the filter base!
5. Screw both locking levers.
6. Close the cover until it locks into position.

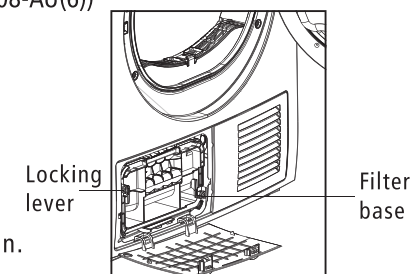

Maintenance cover

# MAINTENANCE

## Note!

- The fluff accumulated on the filter will block the air circulation, which will cause the extension of drying time and energy consumption.
- Do disconnect the power cord before cleaning!
- Do not operate the dryer without the filter!
- Clean the filter after each use to prevent lint accumulation inside the dryer.

## Clean heat exchanger (Only MDS70-CH05/B08-AU(6))

- As necessary, approx. once every 2 months, remove the fluff from the heat exchanger using the sponge or soft brush.
- When doing this, please use gloves.

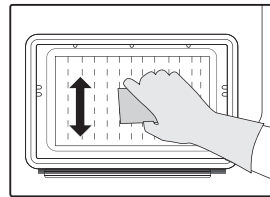

## Note!

- The fluff can be removed more easily if it is first dampened.

## Wash air condenser (Only MDS70-C05/B08-AU(2))

Leave the dryer to cool down.

Residual water may escape, place an absorbent cloth under the maintenance cover.

1. Unlock the maintenance cover.
2. Completely open maintenance cover.
3. Screw both locking levers towards each other.
4. Pull out the air condenser.
5. Clean the air condenser completely, drain thoroughly.
6. Clean the seals.
7. Re-insert the air condenser, handle at the button!
8. Unscrew both locking levers.
9. Close the maintenance cover until it locks into position.  
Please clean the air condenser approx. once every 3 months if frequently used.  
Do not damage the air condenser!

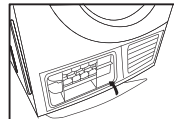
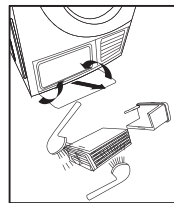
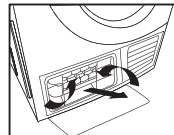
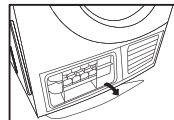

## Warning!

- Clean with water only; do not use hard/sharp-edged objects!  
Do not operate the dryer without the air condenser!
- During drying, water may collect between the window and the seal, but this does not affect the function of your dryer!

# MAINTENANCE

## Trouble Shooting

Display	Reason	Solutions
"Full" LED on permanently	Container is full	Empty container
	Water pump failure or water level sensor failure	Please contact your local service center if the problem persists
Child Lock + 9h	Temperature sensor error	
Child Lock + 6h	Humidity sensor error	
Child Lock + 3h (Only MDS70-C05/B08-AU(2))	Heating problem	

## Warning!

- Only authorised technicians can carry out repairs.
- Before you call service, please check if you have dealt with the fault yourself or if you have followed the user instructions.
- A technician will charge you for advice, even during the warranty period.

## MAINTENANCE

Problem	Solution
<ul style="list-style-type: none"> <li>• Working state LED not on</li> </ul>	<ul style="list-style-type: none"> <li>• The mains plug is inserted.</li> <li>• Check the programme selected.</li> <li>• Check fuse in the house.</li> </ul>
<ul style="list-style-type: none"> <li>• "Full" LED on permanently</li> </ul>	<ul style="list-style-type: none"> <li>• Empty condensation container.</li> <li>• If failure, check hose for condensation outlet.</li> </ul>
<ul style="list-style-type: none"> <li>• Dryer does not start</li> </ul>	<ul style="list-style-type: none"> <li>• Check the start button has selected .</li> <li>• Check the the door has closed.</li> <li>• Check the programme has set.</li> </ul>
<ul style="list-style-type: none"> <li>• Water is running out</li> </ul>	<ul style="list-style-type: none"> <li>• Align dryer horizontally.</li> <li>• Clear air condenser and door seals.</li> </ul>
<ul style="list-style-type: none"> <li>• Door is open by itself</li> </ul>	<ul style="list-style-type: none"> <li>• Press door until it "clicks" into position.</li> <li>• Check the clothes is over load .</li> </ul>
<ul style="list-style-type: none"> <li>• Humidity in the room is increase significantly</li> </ul>	<ul style="list-style-type: none"> <li>• Ventilate room adequately.</li> <li>• Clean the cool grille.</li> <li>• Ensure that the air condenser has been inserted.</li> </ul>
<ul style="list-style-type: none"> <li>• Degree of dryness was not reached or drying time too long</li> </ul>	<ul style="list-style-type: none"> <li>• Clean lint filter and wash condenser.</li> <li>• Empty container.</li> <li>• Check water outlet.</li> <li>• Dryer installation too restricted.</li> <li>• Clean the moisture sensors.</li> <li>• Use next higher drying programme or using Timer programme.</li> </ul>

### Warning!

If you cannot deal with the fault by yourself and need help:

- Press the **【On/Off】** button.
- Pull out the mains plug and call the service.

## MAINTENANCE

### ■ Technical Specifications

Model	DR7WHP	DR7WCON
Parameter		
Dimension(L*W*H)	622*595*845(mm)	622*595*845(mm)
Ambient temperature	+5°C ~ +35°C	+5°C ~ +35°C
Rated input power	850W	2000W
Rated voltage	220-240V~	220-240V~
Rated frequency	50Hz	50Hz
Refrigerant	R134a	—
Weight of product	51kg	41kg
Rated capacity	7.0kg	7.0kg

Contains fluorinated greenhouse gases covered by the Kyoto Protocol.  
Hermetically sealed.

### Note!

- The rated capacity is the maximum capacity, make sure that the dry clothes which are loaded to the appliance do not exceed the rated capacity each time.
- Do not install the tumble dryer in a room when there is a risk of frost occurring. At temperatures around freezing point the tumble dryer may not be able to operate properly.
- There is a risk of damage if the condensate water is allowed to freeze in the pump, hoses and / or condensate water container.