



# Installation and Operating Instructions

## **Model:**

**RC6S1000**  
**RC6S700**  
**RC6W1000**  
**RC6W700**  
**RC9B1000**  
**RC9S1000**  
**RC9S700**

As part of Parmco Appliances commitment to improving and updating product ranges, we reserve the right to alter, change and update technical specifications and appearance attributes of all Parmco Appliances products. E&OE

*V20251203*

# PARMCO

Inspiring kitchens, entertaining homes

p: 09 573 5678  
f: 09 573 5699  
e: sales@parmco.co.nz  
w: www.parmco.co.nz

## *Parmco Appliances extended 7 year warranty*



### The Warranty:

- This appliance is intended for domestic use in the owners' home. Use of the appliance for commercial purposes will limit the warranty period (please see Parmco website for commercial details).
- Subject to the terms and conditions contained within this warranty, if the product is not of Acceptable Quality (as defined in the Consumer Guarantees Act) within 7 years of the date of original purchase, then Parmco Sales undertakes to repair or, at its sole discretion, replace the product.
- The warranty does not cover the costs of transport, mileage or travelling time if the product is located beyond 30km of a recognised Service Agent.
- This warranty is offered as an extra benefit, and does not affect other legal rights, which can not be modified or excluded by agreement.
- This warranty only applies to goods supplied and installed in the North and South Islands of New Zealand.
- The provisions of this warranty are in addition to the rights and remedies available to consumers under the Consumer Guarantees Act 1993.

### The Warranty is not valid:

- If the product is not installed and operated in accordance with the operating instructions.
- If the product is not installed to comply with the electrical, gas, plumbing and other Regulations and Codes of Practice in New Zealand.
- If the product is operated on voltages or frequencies outside the normal range for domestic appliances in New Zealand.
- If the product is not used in normal domestic use, or if it is used in a business as defined in the Consumer Guarantees Act.
- If any serial number has been removed or defaced.
- If proof of date of purchase is not supplied, except at the sole discretion of Parmco Sales. Proof of purchase can be for the product itself, or if installed with a kitchen or house then proof of purchase can be from a Parmco reseller of products supplied by Parmco.
- If the products are purchased in a second hand condition from other parties (including but not limited to TradeMe, Sella, etc.)

### Liability under this warranty will not be accepted for:

- Wear and tear caused by normal domestic use of the product.
- Damage in transport.
- Damage caused to the product by neglect, abuse, negligence, wilful act or misuse.
- Any costs associated with the repair, replacement, removal or reinstallation of products installed in a damaged condition.
- Any defect caused by accident, misuse, neglect, tampering with or unauthorised modifications of the appliance or any attempt at internal adjustment or repair by any person other than an Authorised Service Agent.
- Service calls that relate principally to the following:
  - Instruction on how to use the product.
  - Repair or replacement of house fuses, electrical wiring, gas fitting or plumbing.
  - Normal or scheduled maintenance including blocked filters or ducting.
  - Consumable items such as light bulbs.
  - Any damage to hobs caused by spills when cooking.
  - Any breakage or damage of glass items.
  - Any damage caused by non recommended product used for cleaning, maintaining, lubricating or similar.
- Any aspect relating to the installation of the product, or damage caused during installation including blocked access for repair.
- Any third party (including reseller) or consequential loss or damage (direct or indirect) however arising.

Product \_\_\_\_\_ Date of purchase \_\_\_\_\_  
Serial Number \_\_\_\_\_  
Dealer / Retailers Name \_\_\_\_\_

Please retain this Warranty card together with receipt or other proof of purchase date when seeking service during the warranty period

Please contact Parmco at 09 573 5678 if your appliance needs servicing under warranty. Please have your model number and proof of purchase ready. Warranty repairs must be authorized by Parmco.

Subject to updates without prior notice, please visit [www.parmco.co.nz](http://www.parmco.co.nz) for the latest version.

E & O.E. 727626062017

---

**100%**  
**NZ OWNED**  
**& OPERATED**

EST. 1989

---

Dear Valued Customer,

Thank you and congratulations on purchasing your new Parmco appliance.

All Parmco products are made to the highest quality and design standards. We are sure you will enjoy your new appliance.

As a note, please read through these instructions carefully. These will assist you in gaining a complete understanding of the functions and features offered by your appliance. Please take special note of all detailed technical information and installation instructions. It is essential that you follow these instructions to ensure the safety and reliability of this appliance.

Furthermore, not using appropriate personnel to install this appliance may affect any future warranty claims lodged, so please check with Parmco Appliances before any installation is carried out.

We hope you enjoy your new appliance. If you would like to find out more about this product or any other products in Parmco's extensive range, visit us online at [www.parmco.co.nz](http://www.parmco.co.nz).

Regards,

**The Parmco Team**

**P A R M C O**

Inspiring kitchens, entertaining homes

<b>Content</b>	<b>Page</b>
<b>IMPORTANT SAFETY INFORMATION</b>	<b>1</b>
<b>SAFETY INFORMATION</b>	<b>2</b>
<b>FEATURES</b>	<b>2</b>
<b>USE AND CARE</b>	<b>3</b>
<b>INSTALLATION</b>	<b>5</b>
<b>MAINTENANCE</b>	<b>7</b>
<b>TROUBLESHOOTING TIPS</b>	<b>9</b>

## **IMPORTANT SAFETY INFORMATION**



For best performance and to extend the life of your appliance we recommend that you read the instructions in this owners' manual thoroughly before using your new appliance. It will provide you with all the information you need to ensure its safe installation, proper use and maintenance. Retain this owners' manual for future reference.

To maintain the efficiency and safety of this appliance we recommend the following:

### **BEFORE USING THIS APPLIANCE**

#### **Read the instructions thoroughly**

- Remove all plastic protective films on the appliance before operating the appliance.
- The brackets and screws to fix this canopy to the wall are provided and are fixed to the inside packaging. Please check that the brackets and screws are not discarded with the packaging.
- This canopy must be installed by a qualified professional.
- Parmco is not liable for any damages or injuries caused as a result of not following the installation instructions in this manual.

## **SAFETY INFORMATION**

- This appliance is designed for non-commercial, household use only and must not be altered in any way.
- This appliance can only be used safely when it is correctly connected to an efficient earthing system in compliance with New Zealand Electrical Standards requirements.
- Before maintenance or cleaning always ensure that the appliance is disconnected from the mains.
- Packaging items such as plastic bags, polystyrene, nails etc that this appliance is delivered in are potentially dangerous, and therefore appropriate measure must be taken to
- Prevent children from coming into contact with them.
- This appliance must only be used by adults. Make sure that children do not touch the controls or play with the appliance. Young children should be supervised to ensure they do not play with the appliance.
- This appliance is not intended for use by persons (including children) with reduced physical, sensory, or mental capabilities, or lack of experience and knowledge, unless they have been given supervision or instruction concerning the use of this appliance by a person responsible for their safety.
- The exposed parts of this appliance heat up during the cooking process and remain hot for some time afterwards, even after it has been switched off. Keep children well away during operation and while the unit is cooling down.
- Keep the appliance thoroughly cleaned. Residues may cause fire risks.
- DO NOT use a steam cleaner to clean this appliance.
- Avoid improper or dangerous use of this appliance.
- Do not obstruct the ventilation or heat dissipation slots.
- This appliance is intended for indoor use only. Avoid exposing the appliance to atmospheric elements such as direct sunlight and rain.
- If the supply cord is damaged, it must be replaced by the a service agent or a similarly qualified person.









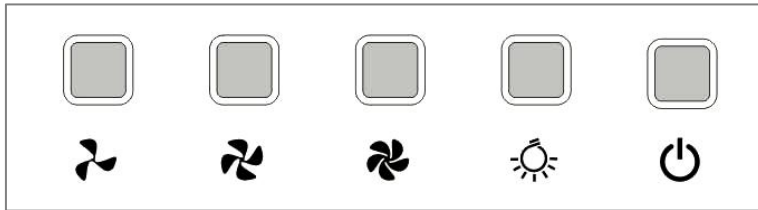











## **FEATURES**

- Your canopy has been constructed using high quality materials.
- Your canopy is fitted with a powerful centrifugal fan and is equipped with a low noise electric motor.
- Your canopy produces strong suction to rapidly ventilate your kitchen environment and each model contains aluminium mesh filters designed to trap grease from the air as it is removed from your kitchen.
- Depending on the model you have purchased you will enjoy either incandescent, halogen or LED lighting from your appliance.





# USE AND CARE

## For models with 5 Electronic Buttons Switch



- After connecting to power, indicator light will lit on, all the output close and the hood will enter standby mode. The indicator light will be off automatically after reminding if no operation.
- Power on: Press power button  once, its indicator light will lit on, the hood works at low speed. Indicator light of low speed  will be bright. Press power button again to close it, and its indicator light will be off. All the function operation of the hood will be closed, the hood enters into standby mode, and run by circle.
- The speed buttons and lamp button can work separately and not controlled by the power button. When a certain function button is pressed, the hood operates at that function status. Press (Power) button under any status, the cooker hood will be switched off without any functions.
- Press lamp button  once; lights will be turn on. Indicator light of lamp button  and power button  will lit on. Press lamp button  again to turn off the lights. Indicator light of lamp button  and power button  will be off. And recycle like this.
- Press the  (High) button once, motor runs on high speed, the indicator light of high button  and power button  will beam. Press high button  again and the motor will stop. Indicator light of high button and power button will be off, and run by circle.
- Press the  (Mid) button once, motor runs on middle speed, the indicator light of middle button  and power button  will beam. Press middle button  again and the motor will stop. Indicator light of middle button and power button will be off, and run by circle.
- Press the  (low) button once, motor runs on low speed, the indicator light of low button  and power button  will beam. Press low button  again and the motor will stop. Indicator light of low button and power button will be off, and run by circle.

## For models with Push Buttons

				
<b>Stop</b>	<b>Low</b>	<b>Mid</b>	<b>High</b>	<b>Light</b>

- Pushbutton “low” and the motor runs at low speed. Push it again and the motor will stop.
- Pushbutton “mid” and the motor runs at medium speed. Push it again and the motor will stop.
- Pushbutton “high” and the motor runs on high speed. Push it again and the motor will stop.
- Push button “light”, the lamps come on. Push it again and the lamps will turn off.

# INSTALLATION

1. The canopy should be placed at a minimum distance of 65 cm above the cooking surface when placed above an electric hob and a minimum of 75 cm above the cooking surface when placed above a gas cooktop. (Refer Pic 1).
2. To install, drill 3 holes of  $\varnothing 8\text{mm}$  along a level line at the desired height. This line will hold the bracket that holds the canopy to the wall. (Refer Pic 2). Insert the screws into the holes and fasten securely to the wall, ensuring that the screws fix into material that has sufficient load capacity to hold the weight of the canopy.
3. Add the ducting to the top of the canopy and fix firmly. Run the ducting to the outside of the building as per the NZ Building Code requirements ensuring that the ducting is not kinked or crimped in any way. (Refer to Pic 3).
4. Calculate the final height of the chimney cover and mark the position of the second bracket. Affix the bracket to the wall at the desired height. (Refer to Pic 4).
5. Lift the first section of chimney cover onto the canopy. Place the second part of the chimney cover inside the first and lift up to the final bracket height. Fix the chimney cover to the top bracket using the screws provided and fix the body using the screws provided. (Refer to Pic 5 and Pic 6).

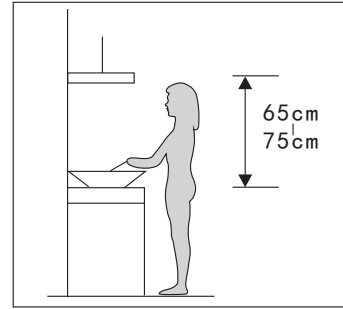

**NOTE: If retrofitting these units into an existing building it may be necessary to remove part of the scotia where the chimney cover meets the ceiling.**

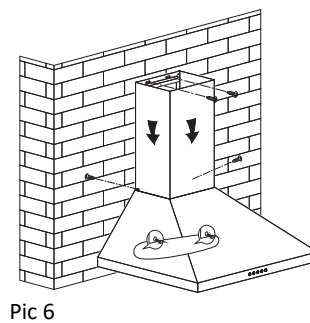
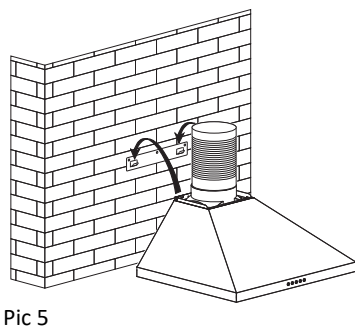
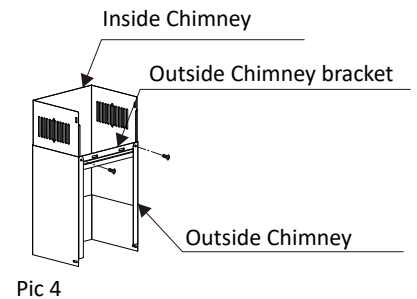
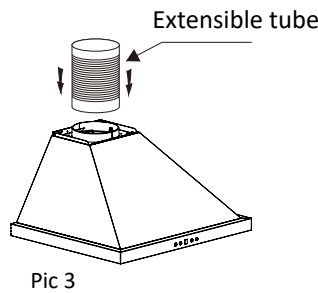
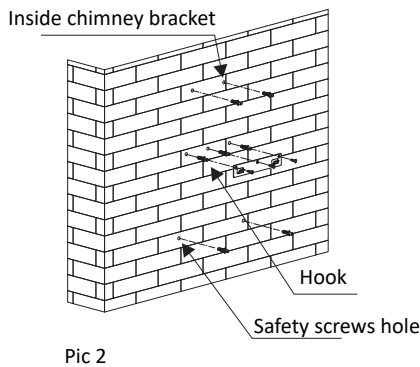

**Installation of kitchen ventilation over electrical and gas cooktops must be undertaken in full accordance and reference to the relevant New Zealand building standards.**

Before installation, please ensure the area is clean to avoid remaining bits of broken wood and dust being sucked into the unit.

**Installation of kitchen ventilation over electrical and gas cooktops must be undertaken in full accordance and reference to the relevant NZ building standards.**

- After the initial installation, check that the unit has been installed level to avoid grease collection at one end.
- When the canopy is located above a gas appliance, the minimum distance from the top of the cooking surface should be at least 75cm and comply with the relevant New Zealand standards.
- When the canopy is located above an electric cooking surface the minimum distance from the top of the cooking surface should be at least 65cm and comply with the relevant New Zealand standards.
- If installation instructions for the gas hob you are using specify a greater distance please follow the hob manufacturer's recommendation.
- Regulations concerning the discharge of air must be adhered to. Please refer to the relevant New Zealand standards.

**NOTE TO INSTALLER: Any reduction in the ducting diameter size from the canopies ventilation outlet may either cause loss of suction, excessive noise or motor failure.**

**Any warranty claim where this is found to be the problem will not be covered under your manufacturer's warranty.**

# MAINTENANCE

## Cleaning of the Mesh Grease Filter



The filter mesh is made of high-density aluminium and stainless steel. Please do not use corrosive detergents on it. If using a dishwasher to clean filters, please ensure that a non-caustic detergent is used. Keeping this filter clean will keep the appliance running correctly.

## Cleaning Method

**Method 1:** Put the mesh into 40-50°C clean soapy water. Allow soaking for several minutes. Clean with a soft brush. Do not apply too much pressure as the mesh is delicate and will damage easily.

**Method 2:** If the detergent used in the dishwasher is of a non-caustic type, mesh filters can be put into a dishwasher. Set the temperature at around 60°C.

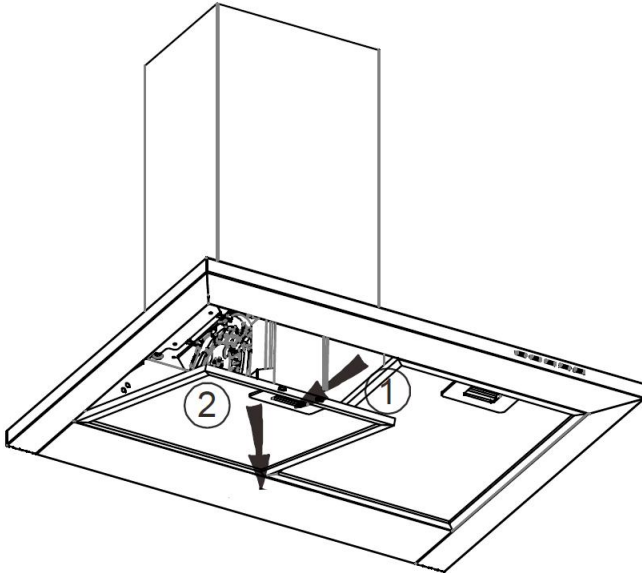

## Cleaning of the Canopy

- Before cleaning the appliance, please remember to turn off the power.
- To protect the main body from corrosion over time, it is essential that the canopy be frequently cleaned with hot water plus non-corrosive detergent.
- It is essential that the unit be dried with a suitable soft cloth after cleaning as residual moisture can promote corrosion.
- Do not use abrasive agents for cleaning, as this will damage the stainless steel body.
- Keep the motor and other spare parts free from water, as this will cause damage to the appliance.

## Replacing the LED Lights (SWITCH THE UNIT OFF AND PULL OUT THE PLUG FIRST)

### 1.5W/2W LED light

1. Remove the grease filter.
2. Use a tool or the hand to press the spring splinter of both sides of LED light to the inside, until the light is pressed out, see pic 1. Then slightly pull the light connecting wire out, and dismantle the terminal of the light connecting wire. See pic 2.
3. Apply the reverse procedure to install the light back.

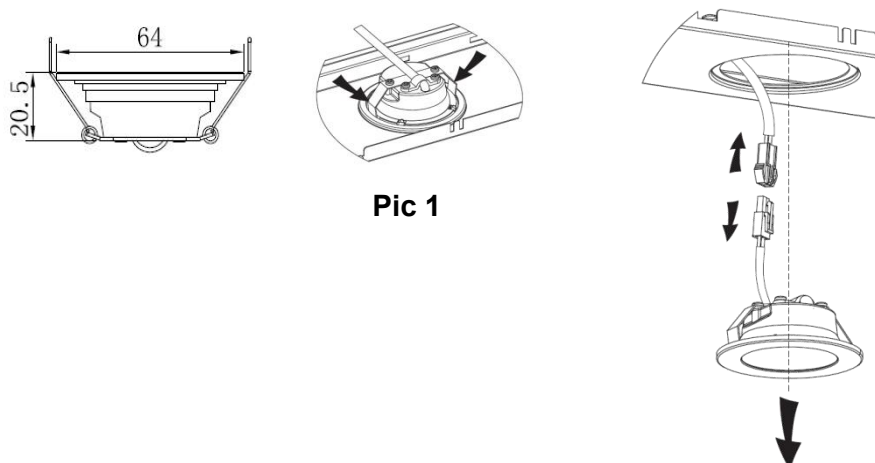

## Technical Data

### 1000m<sup>3</sup>/h models

<b>Model</b>	<b>RC9B1000, RC6W1000, RC6S1000, RC9S1000</b>
Rated voltage	220-240V/50Hz
Lighting power	≤ 1.5W + 1.5W
Motor power	330W
Duct diameter	150mm
Air flow	1000 m <sup>3</sup> /h

### 700m<sup>3</sup>/h models

<b>Model</b>	<b>RC6W700, RC6S700, RC9S700</b>
Rated voltage	220-240V/50Hz
Lighting power	≤ 2W + 2W
Motor power	220W
Duct diameter	150mm
Air flow	700 m <sup>3</sup> /h

## TROUBLESHOOTING TIPS

If any problem occurs, please remove the plug from the socket and contact Parmco service department at 09 573 5678.

<b>Problem</b>	<b>Solution</b>
Lights don't work, but motor works	Change the bulb
	Call Parmco service department
Lights work, but motor does not work	Restart the motor
	Call Parmco service department
Lights don't work, motor doesn't work	Call Parmco service department
The body of the rangehood shakes	Remove obstructions in the ducting
	Make sure the installation is secure
	Call Parmco service department
Insufficient suction	Readjust the distance between the rangehood and the cooktop
	Reduce cross-ventilation or open the window
	Adjust the length of the exhaust pipe
	Check the outlet valve is open
	Call Parmco service department