

PARMCO

Installation and Operating Instructions

Model:

RR6S700

As part of Parmco Appliances commitment to improving and updating product ranges, we reserve the right to alter, change and update technical specifications and appearance attributes of all Parmco Appliances products. E&OE

V20251218

PARMCO

inspiring kitchens, entertaining homes

p: 09 573 5678
f: 09 573 5699
e: sales@parmco.co.nz
w: www.parmco.co.nz

Parmco Appliances extended 7 year warranty



The Warranty:

- This appliance is intended for domestic use in the owners' home. Use of the appliance for commercial purposes will limit the warranty period (please see Parmco website for commercial details).
- Subject to the terms and conditions contained within this warranty, if the product is not of Acceptable Quality (as defined in the Consumer Guarantees Act) within 7 years of the date of original purchase, then Parmco Sales undertakes to repair or, at its sole discretion, replace the product.
- The warranty does not cover the costs of transport, mileage or travelling time if the product is located beyond 30km of a recognised Service Agent.
- This warranty is offered as an extra benefit, and does not affect other legal rights, which can not be modified or excluded by agreement.
- This warranty only applies to goods supplied and installed in the North and South Islands of New Zealand.
- The provisions of this warranty are in addition to the rights and remedies available to consumers under the Consumer Guarantees Act 1993.

Product _____ Date of purchase _____
Serial Number _____
Dealer / Retailers Name _____

Please retain this Warranty card together with receipt or other proof of purchase date when seeking service during the warranty period

Please contact Parmco at 09 573 5678 if your appliance needs servicing under warranty. Please have your model number and proof of purchase ready. Warranty repairs must be authorized by Parmco.

The Warranty is not valid:

- If the product is not installed and operated in accordance with the operating instructions.
- If the product is not installed to comply with the electrical, gas, plumbing and other Regulations and Codes of Practice in New Zealand.
- If the product is operated on voltages or frequencies outside the normal range for domestic appliances in New Zealand.
- If the product is not used in normal domestic use, or if it is used in a business as defined in the Consumer Guarantees Act.
- If any serial number has been removed or defaced.
- If proof of date of purchase is not supplied, except at the sole discretion of Parmco Sales. Proof of purchase can be for the product itself, or if installed with a kitchen or house then proof of purchase can be from a Parmco reseller of products supplied by Parmco.
- If the products are purchased in a second hand condition from other parties (including but not limited to TradeMe, Sella, etc.)

Liability under this warranty will not be accepted for:

- Wear and tear caused by normal domestic use of the product.
- Damage in transport.
- Damage caused to the product by neglect, abuse, negligence, wilful act or misuse.
- Any costs associated with the repair, replacement, removal or reinstallation of products installed in a damaged condition.
- Any defect caused by accident, misuse, neglect, tampering with or unauthorised modifications of the appliance or any attempt at internal adjustment or repair by any person other than an Authorised Service Agent.
- Service calls that relate principally to the following:
 - Instruction on how to use the product.
 - Repair or replacement of house fuses, electrical wiring, gas fitting or plumbing.
 - Normal or scheduled maintenance including blocked filters or ducting.
 - Consumable items such as light bulbs.
 - Any damage to hobs caused by spills when cooking.
 - Any breakage or damage of glass items.
 - Any damage caused by non recommended product used for cleaning, maintaining, lubricating or similar.
- Any aspect relating to the installation of the product, or damage caused during installation including blocked access for repair.
- Any third party (including reseller) or consequential loss or damage (direct or indirect) however arising.

Subject to updates without prior notice, please visit www.parmco.co.nz for the latest version.

E & O.E. 727626032017



Dear Valued Customer,

Thank you and congratulations on purchasing your new Parmco appliance. All Parmco products are made to the highest quality and design standards. We are sure you will enjoy your new appliance.

As a note, please read through these instructions carefully. These will assist you in gaining a complete understanding of the functions and features offered by your appliance. Please take special note of all detailed technical information and installation instructions. It is essential that you follow these instructions to ensure the safety and reliability of this appliance.

Furthermore, not using appropriate personnel to install this appliance may affect any future warranty claims lodged, so please check with Parmco Appliances before any installation is carried out.

We hope you enjoy your new appliance. If you would like to find out more about this product or any other products in Parmco's extensive range, visit us online at www.parmco.co.nz.

Regards,
The Parmco Team

PARMCO

Inspiring kitchens, entertaining homes

Content	Page
IMPORTANT SAFETY INFORMATION	1
SAFETY INFORMATION	2
INSTALLATION	3
OPERATION	5
MAINTENANCE	6
TROUBLESHOOTING TIPS	8

IMPORTANT SAFETY INFORMATION



For best performance and to extend the life of your appliance we recommend that you read the instructions in this owners' manual thoroughly before using your new appliance. It will provide you with all the information you need to ensure its safe installation, proper use and maintenance. Retain this owners' manual for future reference.

To maintain the efficiency and safety of this appliance we recommend the following:

BEFORE USING THIS APPLIANCE

Read the instructions thoroughly

- Remove all plastic protective films on the appliance before operating the appliance.
- The brackets and screws to fix this canopy to the wall are provided and are fixed to the inside packaging. Please check that the brackets and screws are not discarded with the packaging.
- This appliance must be installed by a qualified professional.
- Parmco is not liable for any damages or injuries caused as a result of not following the installation instructions in this manual.

Safety Information

- This appliance is designed for non-commercial, household use only and must not be altered in any way.
- This appliance can only be used safely when it is correctly connected to an efficient earthing system in compliance with New Zealand Electrical Standards requirements.
- Before maintenance or cleaning always ensure that the appliance is disconnected from the mains.
- Packaging items such as plastic bags, polystyrene, nails etc that this appliance is delivered in are potentially dangerous, and therefore appropriate measure must be taken to prevent children from coming into contact with them.
- This appliance must only be used by adults. Make sure that children do not touch the controls or play with the appliance. Young children should be supervised to ensure they do not play with the appliance.
- This appliance is not intended for use by persons (including children) with reduced physical, sensory, or mental capabilities, or lack of experience and knowledge, unless they have been given supervision or instruction concerning the use of this appliance by a person responsible for their safety.
- The exposed parts of this appliance heat up during the cooking process and remain hot for some time afterwards, even after it has been switched off. Keep children well away during operation and while the unit is cooling down.
- Do not do any flambé cooking underneath the hood.
- When frying, never leave the pan alone because the cooking oil could flare up.
- Keep the appliance thoroughly cleaned. Residues may cause fire risks.
- DO NOT use a steam cleaner to clean this appliance.
- Avoid improper or dangerous use of this appliance.
- Do not obstruct the ventilation or heat dissipation slots.
- This appliance is intended for indoor use only. Avoid exposing the appliance to atmospheric elements such as direct sunlight and rain.
- If the supply cord is damaged, it must be replaced by the manufacturer or a service agent or a similarly qualified person.

Installation

Before installation, please ensure the area is clean to avoid remaining bits of broken wood and dust being sucked into the unit.

The appliance can be used as a rangehood or can be mounted beneath a wall cupboard and is suitable for use as an exhaust hood or as a recirculating hood; if an exhaust facility (an exhaust duct or a ventilating shaft) is available, then we recommend the hood be installed as an exhaust hood for then, most of the smells and vapours that arise when cooking or frying can be almost completely removed from the kitchen.

Fastening the cooker hood on the wall

1. The rangehood should be placed at a minimum distance of 65cm above the cooking surface when placed above an electric hob and a minimum of 75cm above the cooking surface when placed above a gas cooktop.
2. To install onto the wall drill 4 holes of $\varnothing 8\text{mm}$ on a suitable place according with the centre distance of hole in the back of the cooker hood.

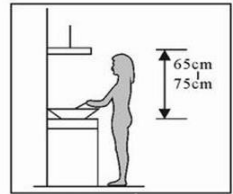

Pic 1

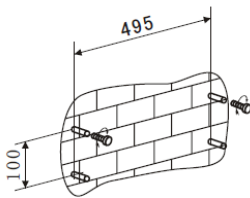

60cm

3. Insert the nut into the holes.
4. Insert the screws into the nuts and tight.
5. Put up the cooker hood onto the fixed screws.

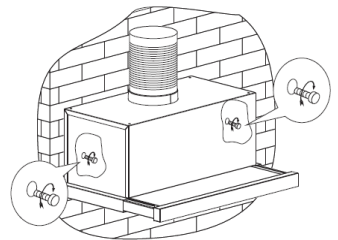
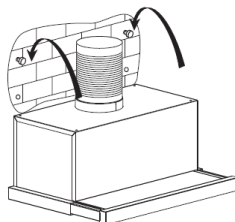
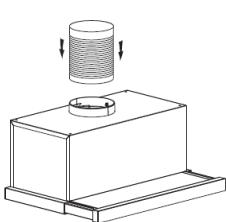

Fastening the cooker hood beneath a wall cupboard (ensure that the cupboard can support the weight of the hood).

1. Drill 4 holes of 4mm diameter at the bottom of the hanging cupboard.

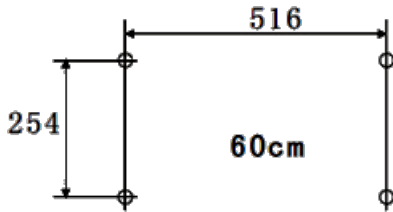

2. Install the cooker hood on the bottom of the cupboard, tighten the hood with the M4 screws.

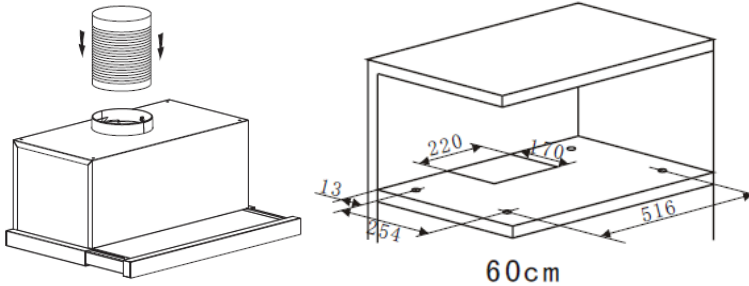



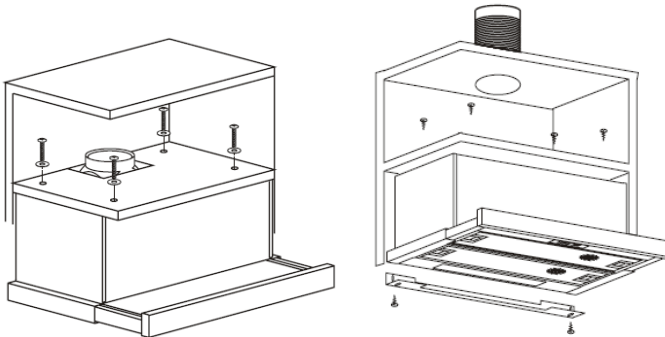





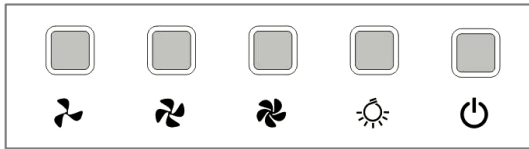











3. Use two 3*12 screws to fix the adjusted board on the bottom of the hood in order to keep out the gap between hood back and cupboard.



Installation of kitchen ventilation over electrical and gas cooktops must be undertaken in full accordance and reference to the relevant New Zealand building standards.

OPERATION



- After connecting to power, indicator light will lit on, all the output close and the hood will enter standby mode. The indicator light will be off automatically after reminding if no operation.
- Power on: Press power button  once, its indicator light will lit on, the hood works at low speed. Indicator light of low speed  will be bright. Press power button again to close it, and its indicator light will be off. All the function operation of the hood will be closed, the hood enters into standby mode, and run by circle.
- The speed buttons and lamp button can work separately and not controlled by the power button. When a certain function button is pressed, the hood operates at that function status. Press (Power) button under any status, the cooker hood will be switched off without any functions.
- Press lamp button  once; lights will be turn on. Indicator light of lamp button  and power button  will lit on. Press lamp button  again to turn off the lights. Indicator light of lamp button  and power button  will be off. And recycle like this.
- Press the  (High) button once, motor runs on high speed, the indicator light of high button  and power button  will beam. Press high button  again and the motor will stop. Indicator light of high button and power button will be off, and run by circle.
- Press the  (Mid) button once, motor runs on middle speed, the indicator light of middle button  and power button  will beam. Press middle button  again and the motor will stop. Indicator light of middle button and power button will be off, and run by circle.
- Press the  (low) button once, motor runs on low speed, the indicator light of low button  and power button  will beam. Press low button  again and the motor will stop. Indicator light of low button and power button will be off, and run by circle.

MAINTENANCE

Cleaning of the Mesh Grease Filter



The filter mesh is made of high-density aluminium and stainless steel. Please do not use corrosive detergents on it. If using a dishwasher to clean filters, please ensure that a non-caustic detergent is used. Keeping this filter clean will keep the appliance running correctly.

In order to prevent fire hazard, it is recommendable to clean the filter every 2 months by carrying out the following instructions.

- Unplug before cleaning, then remove the filters from the cooker hood and wash them in a solution of water and neutral liquid detergent, leaving to soak.
- Rinse thoroughly with warm water and leave to dry.
- The filters can be washed in the dishwasher, however different detergents have different caustic content and the aluminium filters may alter in colour.
- It can be washed at more or less frequent intervals depending on how often the hood is used.
- Clean the surfaces of the cooker hood regularly using a cloth moistened with denatured alcohol or non-abrasive liquid detergent.
- Keep the motor and other spare parts free from water, as this will cause damage to the appliance.
- Replace filters approximately every 4 months.
- There is a fire risk if cleaning is not carried out in accordance with the instruction

Cleaning Method

Method 1: Put the mesh into 40-50°C clean soapy water. Allow soaking for several minutes. Clean with a soft brush. Do not apply too much pressure as the mesh is delicate and will damage easily.

Method 2: If the detergent used in the dishwasher is of a non-caustic type, mesh filters can be put into a dishwasher. Set the temperature at around 60°C.

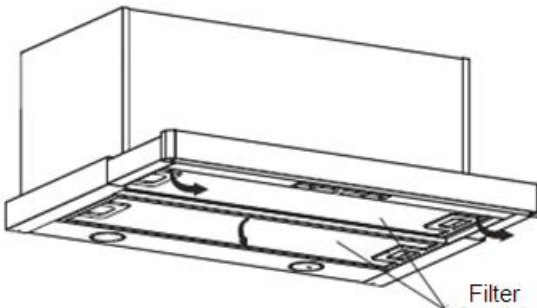

Replacing the LED Lights (SWITCH THE UNIT OFF AND PULL OUT THE PLUG FIRST)

1. Remove the grease filter.
2. Use a tool or the hand to press the spring splinter of both sides of LED light to the inside, until the light is pressed out, see pic 1. Then slightly pull the light connecting wire out, and dismantle the terminal of the light connecting wire. See pic 2.
3. Apply the reverse procedure to install the light back.

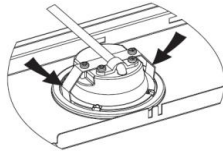
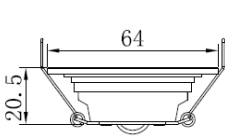

Pic 1

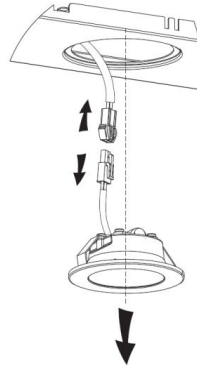

Pic 2

Technical Data

700m³/h models

Model	RR6S700
Rated voltage	220-240V/50Hz
Lighting power	≤ 1.5W + 1.5W
Motor power	220W
Duct diameter	150mm
Air flow	700 m ³ /h

TROUBLESHOOTING TIPS

If any problem occurs, please remove the plug from the socket and contact Parmco service department at [09 573 5678](tel:095735678).

Problem	Solution
Lights don't work, but motor works	Change the bulb
	Call Parmco service department
Lights work, but motor does not work	Restart the motor
	Call Parmco service department
Lights don't work, motor doesn't work	Call Parmco service department
The body of the rangehood shakes	Remove obstructions in the ducting
	Make sure the installation is secure
	Call Parmco service department
Insufficient suction	Readjust the distance between the rangehood and the cooktop
	Reduce cross-ventilation or open the window
	Adjust the length of the exhaust pipe
	Check the outlet valve is open
	Call Parmco service department