

PARMCO

# Installation and Operating Instructions

## Models:

**WM55WT**  
**WM7WT**  
**WM10WT**

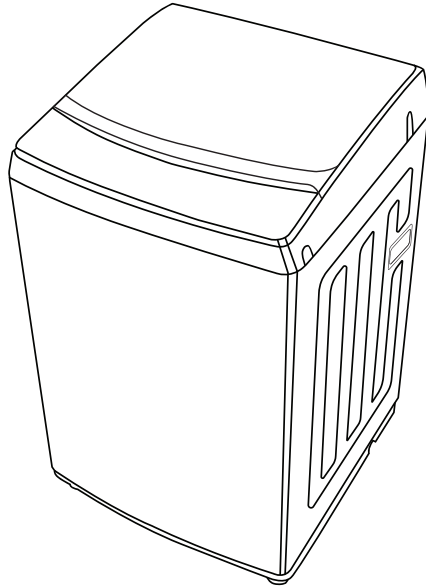

As part of Parmco Appliances commitment to improving and updating product ranges, we reserve the right to alter, change and update technical specifications and appearance attributes of all Parmco Appliances products. E&OE.

## *Parmco Appliances extended 7 year warranty*



### **The Warranty:**

- Subject to the terms and conditions contained within this warranty, if the product is not of Acceptable Quality (as defined in the Consumer Guarantees Act) within 2 years of the date of original purchase, then Parmco Sales undertakes to repair or, at its sole discretion, replace the product.
- The warranty does not cover the costs of transport, mileage or travelling time if the product is located beyond 30km of a recognised Service Agent.
- This warranty is offered as an extra benefit, and does not affect other legal rights, which can not be modified or excluded by agreement.
- This warranty only applies to goods supplied and installed in the North and South Islands of New Zealand.
- The provisions of this warranty are in addition to the rights and remedies available to consumers under the Consumer Guarantees Act 1993.
- Products purchased as seconds or thirds may or may not carry a warranty. Please check with your reseller at the time of purchase for the warranty period being offered.

### **The Warranty is not valid:**

- If the product is not installed and operated in accordance with the operating instructions.
- If the product is not installed to comply with the electrical, gas, plumbing and other Regulations and Codes of Practice in New Zealand.
- If the product is operated on voltages or frequencies outside the normal range for domestic appliances in New Zealand.
- If the product is not used in normal domestic use, or if it is used in a business as defined in the Consumer Guarantees Act.
- If any serial number has been removed or defaced.
- If proof of date of purchase is not supplied, except at the sole discretion of Parmco Sales. Proof of purchase can be for the product itself, or if installed with a kitchen or house then proof of purchase can be from a Parmco reseller of products supplied by Parmco.
- If the products are purchased in a second hand condition from other parties (including but not limited to TradeMe, Sella, etc.)

### **Liability under this warranty will not be accepted for:**

- Wear and tear from normal domestic use.
- Damage in transport.
- Damage caused to the product by neglect, abuse, negligence, wilful act or misuse.
- Any costs associated with the repair, replacement, removal or reinstallation of products installed in a damaged condition.
- Any defect caused by accident, misuse, neglect, tampering with or unauthorised modifications of the appliance or any attempt at internal adjustment or repair by any person other than an Authorised Service Agent.
- Service calls that relate principally to the following:
  - Instruction on how to use the product.
  - Repair or replacement of house fuses, electrical wiring, gas fitting or plumbing.
- Wear and tear caused by normal use of the product.
- Normal or scheduled maintenance including blocked filters or ducting.
- Consumable items such as light bulbs.
- Any damage to hobs caused by spills when cooking.
- Any breakage or damage of glass items.
- Any damage caused by non recommended product used for cleaning, maintaining, lubricating or similar.
- Any aspect relating to the installation of the product, or damage caused during installation including blocked access for repair.
- Any third party (including reseller) or consequential loss or damage (direct or indirect) however arising.

Product \_\_\_\_\_ Date of purchase \_\_\_\_\_

Dealer / Retailers Name \_\_\_\_\_

Please retain this Warranty card together with receipt or other proof of purchase date when seeking service during the warranty period

Please contact Parmco at 09 573 5678 if your appliance needs servicing under warranty. Please have your model number and proof of purchase ready. Warranty repairs must be authorized by Parmco.

Dear Valued Customer,

Thank you and congratulations on purchasing your new Parmco appliance.

All Parmco products are made to the highest quality and design standards. We are sure you will enjoy your new appliance.

As a note, please read through these instructions carefully. These will assist you in gaining a complete understanding of the functions and features offered by your appliance. Please take special note of all detailed technical information and installation instructions. It is essential that you follow these instructions to ensure the safety and reliability of this appliance.

Furthermore, not using appropriate personnel to install this appliance may affect any future warranty claims lodged, so please check with Parmco Appliances before any installation is carried out.

We hope you enjoy your new appliance. If you would like to find out more about this product or any other products in Parmco's extensive range, visit us online at [www.parmco.co.nz](http://www.parmco.co.nz).

Regards,  
**The Parmco Team**

**P A R M C O**

Inspiring kitchens, entertaining homes

# CONTENTS

---

## SAFETY INSTRUCTIONS

- Safety instructions ..... 2

## INSTALLATION

- Product description ..... 8
- Installation area ..... 9
- Unpacking the washing machine ..... 9
- Levelling the washing machine ..... 10
- Selection of tap ..... 11
- Connection of inlet hose, tap and washing machine... 11

## OPERATIONS

- Preparation before washing..... 12
- Washing ..... 12
- After washing..... 12
- Washing matters needing attention ..... 13
- The usage of detergent and washing powder..... 13
- Control panel ..... 14
- Option..... 15
- Personalized setting of washing program..... 16
- Operations of washing process..... 16
- Washing program table ..... 17

## MAINTENANCE

- Cleaning and care ..... 18
- Cleaning the cabinet..... 18
- Cleaning drain pump filter ..... 19
- Troubleshooting..... 20
- Technical information ..... 21
- Energy efficiency test program..... 22

# SAFETY INSTRUCTIONS

---

## ■ SAFETY INSTRUCTIONS

For your safety, the information in this manual must be followed to minimize the risk of fire or explosion, electric shock, or to prevent property damage, personal injury or loss of life.

- This appliance is not intended for use by persons (including children) with reduced physical, sensory or mental capabilities or lack of experience and knowledge unless they have been given supervision or instruction concerning use of the appliance by a person responsible for their safety.
- Children should be supervised to ensure that they do not play with the appliance.
- If the supply cord is damaged, it must be replaced by the manufacturer, its service agent or similarly qualified persons in order to avoid a hazard.
- The new hose-sets supplied with the appliance are to be used and that old hose-sets should not be reused.
- The openings must not be obstructed by a carpet.
- This appliance is intended to be used in household.

# SAFETY INSTRUCTIONS

---

Model	Washing Capacity	Standard Water Pressure
WM55WT	5.5kg	0.03MPa~0.8MPa
WM7WT	7.0kg	0.03MPa~0.8MPa
WM10WT	10.0kg	0.03MPa~0.8MPa

## Explanation of the symbols:



### Warning!

This combination of symbol and signal word indicates a potentially dangerous situation which may result in death or serious injuries unless it's avoided.



### Caution!

This combination of symbol and signal word indicates a potentially dangerous situation which may result in slight or minor injuries or damage to property and the environment.



### Note!

This combination of symbol and signal word indicates a potentially dangerous situation which may result in slight or minor injuries.

# SAFETY INSTRUCTIONS

---



Warning!

The electric shock!

- This appliance is for indoor use only.
- Do not put washing machine at humid place.
- Hands shall not be inserted into running spin-dry tub .
- If the spin-dry tub does not stop within 15 seconds after opening the cover , please stop using the machine and have it repaired.
- Before any maintenance the device, unplug the appliance from the mains.
- Always unplug the machine and turn off the water supply after use. The max. inlet water pressure, in pascals. The min. inlet water pressure, in pascals.
- To ensure your safety, power plug must be inserted into an earthed three-pole socket. Check carefully and make sure that your socket is properly and reliably earthed.
- Make sure that the water and electrical devices must be connected by a qualified technician in accordance with the manufacturer's instructions and local safety regulations.

# SAFETY INSTRUCTIONS

---

## Risk to children!

- EN countries: the appliance can be used by children aged from 8 years and above and persons with reduced physical, sensory or mental capabilities or lack of experience and knowledge if they have been given supervision or instruction concerning use of the appliance in a safe way and understand the hazards involved. Children shall not play with the appliance. Cleaning and user maintenance shall not be made by children without supervision.
- Animals and children may climb into the machine. Check the machine before every operation.
- Young children should be supervised that they do not play with the appliance.
- Machine may be very hot during the operation. Keep kids and pets far away from the machine during the operation very wet rooms as well as in the rooms with explosive or caustic gas.
- **Remove all packages before using the appliance. Otherwise, serious damage may result.**
- The washing machine with single inlet valve only can be connected to the cold water supply. The product with double inlet valves should be correctly connected to the hot water and cold water supply.
- Plug must be accessible after installation.

## Risk of explosion!

- Do not wash or dry articles that have been cleaned in, washed in, soaked in, or dabbed with combustible or explosive substances( such as wax, oil, paint, gasoline, degreasers, dry-cleaning solvents, kerosene, etc.) This may result in fire or explosion.
- Before hand thoroughly rinse items of washing by hand.



# SAFETY INSTRUCTIONS

---



## Caution

### Installing the product!

- This washing machine is for indoor use only.
- It isn't intended to be built-in using.
- The openings must not be obstructed by a carpet.
- Washing machine shall not be installed in bath room or very wet rooms as well as in the rooms with explosive or caustic gases.
- Remove all packages and transport bolts before using the appliance. Otherwise, serious damage may result.
- The washing machine with single inlet valve only can be connected to the cold water supply. The product with double inlet valves should be correctly connected to the hot water and cold water supply.
- Plug must be accessible after installation.

### Risk of damaging appliance!

- Your product is only for home use and is only designed for the textiles suitable for machine washing.
- Do not climb up and sit on top cover of the machine.
- Do not lean against machine door.
- Cautions during Handling Machine:
  - 1.Transport bolts shall be reinstalled to the machine by a specialized person.
  - 2.The accumulated water shall be drained out of the machine.
  - 3.Handle the machine carefully. Never hold each protruded part on the machine while lifting. Machine door can not be used as the handle during the conveyance.
  - 4.This appliance is heavy. Transport with care.

# SAFETY INSTRUCTIONS

---

- Please do not close the door with excessive forces.
- It is forbidden to wash carpets.

## Operating the appliance!

- Before washing the clothes at first time, the product shall be operated in one round of the whole procedures without the clothes inside.
- Flammable and explosive or toxic solvents are forbidden. Gasoline and alcohol etc. Shall not be used as detergents. Please only select the detergents suitable for machine washing, especially for drum.
- Make sure that all pockets are emptied. Sharp and rigid items such as coin, brooch, nail, screw or stone etc. may cause serious damages to this machine.
- Please check whether the water inside the drum has been drained before opening its door. Please do not open the door if there is any water visible.
- Be careful of burning when the product drains hot washing water.
- Never refill the water by hand during washing.
- After the program is completed, Please wait for two minutes to open the door.

## Packaging/Old appliance



This marking indicates that this product should not be disposed with other household wastes throughout the EU. To prevent possible harm to the environment or human health from uncontrolled waste disposal, recycle it responsibly to promote the sustainable reuse of material resources. To return your used device, please use the collection systems or contact the retailer where the product was purchased. They return and can take this product for environmental safe recycling.

# INSTALLATION

## ■ Product Description

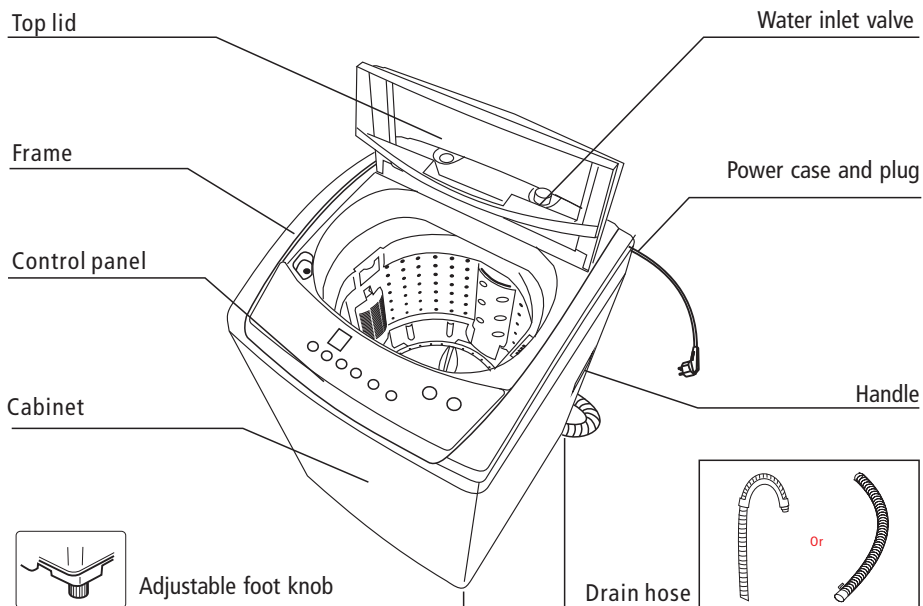

### 📌 Note!

- The product line chart is for reference only, please refer to real product as standard.

## Accessories

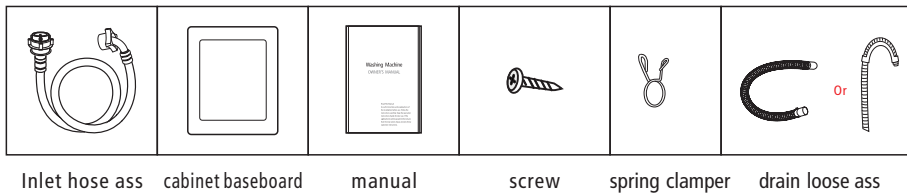

### 📌 Note!

- Note: if the drain hose is already installed on the machine, then there is no spring clamer and drain hose in the accessories.

# INSTALLATION

## ■ Installation area

### ⚠ Warning!

- Stability is important to prevent the product from wandering!
- Make sure that the product should not stand on the power cord.

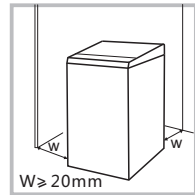

Before installing the machine, the location characterized as follows shall be selected:

1. Rigid, dry, and level surface
2. Avoid direct sunlight
3. Sufficient ventilation
4. Room temperature is above 0 °C
5. Keep far away from the heat resources such as coal or gas.

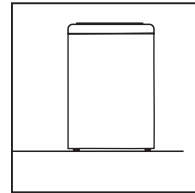

## ■ Unpacking the washing machine

### ⚠ Warning!

- Packaging material (e.g. Films, Styrofoam) can be dangerous for children.
- There is a risk of suffocation ! Keep all packaging well away from children.

1. Remove the cardboard box and styrofoam packing.
2. Lift the washing machine and remove the base packing.
3. Remove the tape securing the power supply cord and drain hose.
4. Remove the inlet hose from the drum.

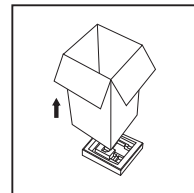

## ■ The installation of drain hose

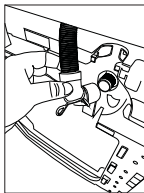

Drain hose inserted into the drain

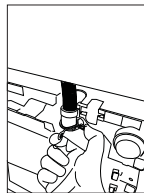

Clamping spring

# INSTALLATION

## ⚠ Warning!

- Do not kink or protract the drain hose.
- Position drain hose properly, otherwise damage might result of water leakage.
- If drain hose is too long, do not force it into washing machine as it will cause abnormal noises.

There are two ways to place the end of drain hose:

### 1. For lower drain system

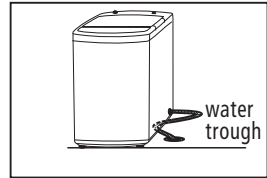
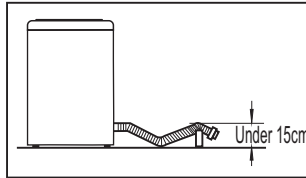
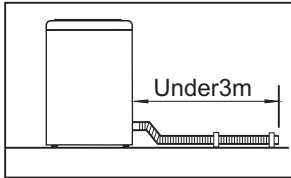

### 2. For upper drain system

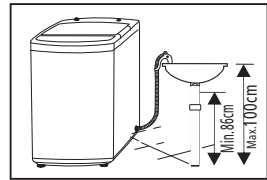
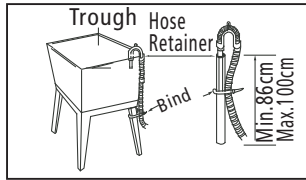
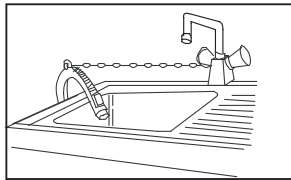

## ■ Levelling the washing machine

## ⚠ Warning!

- The lock nuts on all four feet must be screwed tightly against the housing.

1. Check if the legs are closely attached to the cabinet. If not, please turn them to their original positions tighten the nuts.
2. Check alignment of the product with a spirit level and if required, correct.
3. Loosen the lock nut and turn the feet until it closely contacts with the floor.
4. After being locked properly, press four corners again to make sure that they has been adjusted properly.

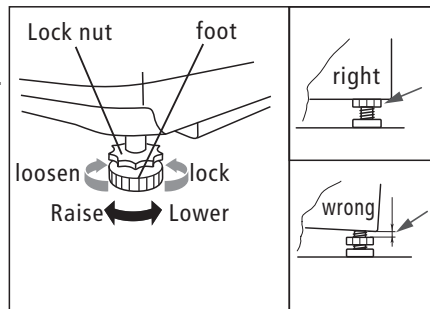

# INSTALLATION

## ■ Selection of Tap

Please select appropriate tap.

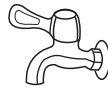

Ordinary faucet



Screw tap



Special washing machine tap

## ■ Connection of inlet hose, tap and washing machine

1: Connection between ordinary tap and inlet hose.

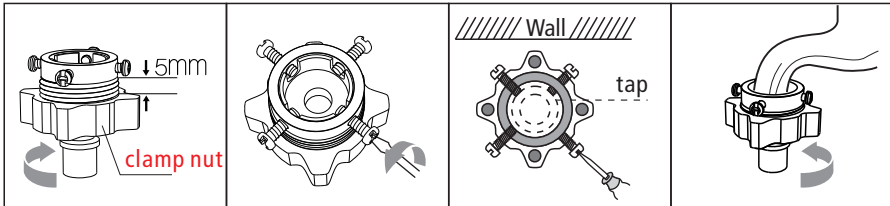

1. Loosen clamp nut to show 5mm thread

2. Loosen four bolts

3. Set connecting base on tap and tighten bolts evenly

4. Tighten clamp nut

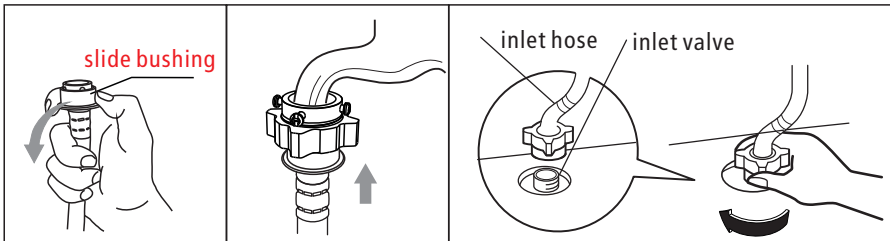

5. Press slide bushing, insert inlet hose into connecting base

6. connection finished

7. After connection and installation, check if there is water leakage

2: connection between screw tap and inlet hose.

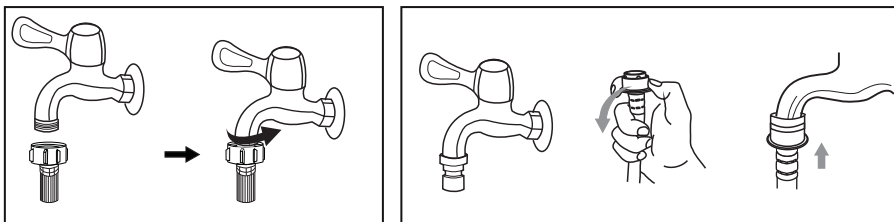

tap with threads and inlet hose

special tap for washing machine

### ⚠ Warning!

- To prevent leakage or water damage, follow the instructions in this chapter!
- Do not kink, crush, modify or sever water inlet hose.

# OPERATIONS

## ■ Preparation Before Washing

### ⚠ Caution!

- Before washing, please make sure it's installed properly.
- Before washing it at first time, the washing machine shall be operated in one round of the whole procedures without clothes in as follows.

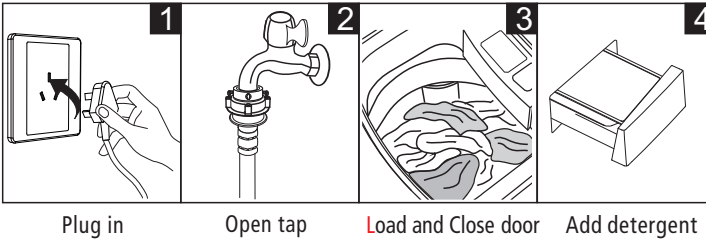

## ■ Washing

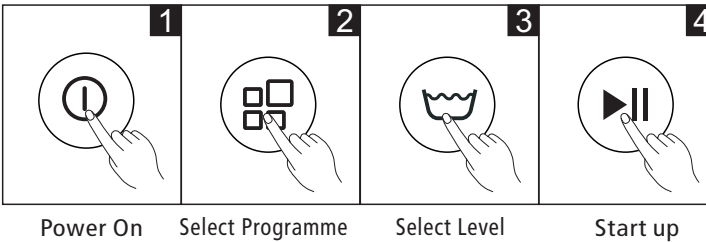

### 📌 Note!

- If default is selected, step 2, 3 can be skipped.

## ■ After Washing

Buzzer will beep after washing finished and the power supply will be cut off automatically. Then unload the laundry.

# OPERATIONS

## ■ Washing matters needing attention

- The working condition of the washer should be (0-40)°C. If used under 0°C, the inlet valve and draining system may be damaged. If the machine is placed under condition of 0°C or less, then it should be transferred to normal ambient temperature to ensure the water supply hose and drain hose are not frozen before use.
- Please check the labels and the explanation of using detergent before wash. Use non-foaming or less-foaming detergent suitable for machine washing properly.

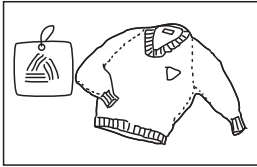

Check the label

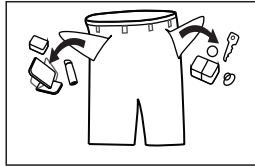

Take out the items out of the pockets

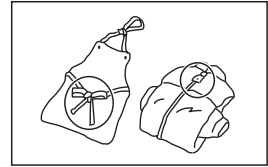

Knot the long strips, zip or button

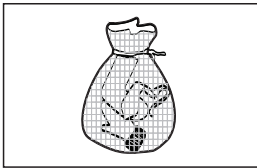

Put small clothes into the pillow slip

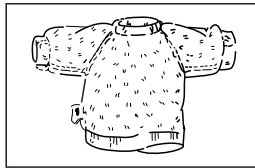

Turn easy-pilling and long-pile fabric inside out

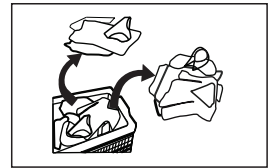

Separate clothes with different textures

### ⚠ Warning!

- When washing a single clothes, it may easily cause great eccentricity and give alarm due to great unbalance. Therefore it is suggested to add one or two more clothes to be washed together so that draining can be done smoothly.
- Don't washing the clothes touching with kerosene, gasoline, alcohol and other flammable materials.

## ■ The usage of detergent and Washing powder

- As for the agglomerated or ropy detergent or additive, before they are poured into the detergent box, it is suggested to use some water for dilution to prevent the inlet of detergent box from being blocked and overflowing while filling water.
- Please choose suitable type of detergent for the various washing temperature to get the best washing performance with less water and energy consumption.



# OPERATIONS

## Control Panel

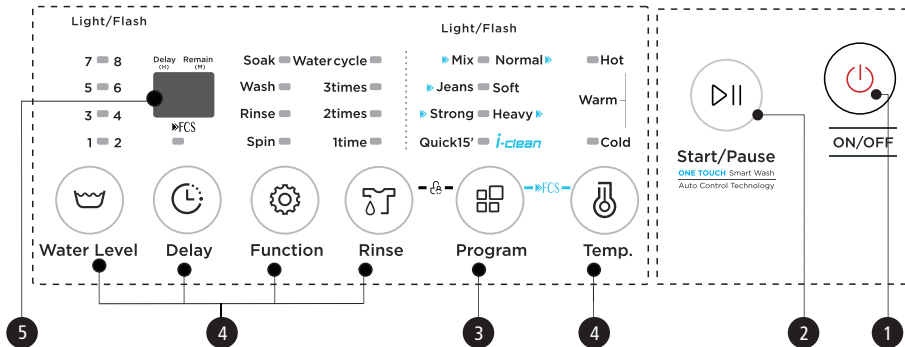

### Note!

- The chart is for reference only, Please refer to real product as standard.

#### 1 On/Off

Product is switched on or off.

#### 2 Start/Pause

Press the button to start or pause the washing cycle.

#### 3 Program

Available according to the laundry type.

#### 4 Option

This allows you to select an additional function and will light when selected.

#### 5 Display

The display shows the settings, estimated time remaining, options, and status messages for your washer. The display will remain on through the cycle.

When LED flashing ,it means the time that delay to start the machine. When LED lighting ,it means the program time that remaining.

# OPERATIONS

## ■ Option

Only for washers having these function.



### Water level

select water level according to clothing categories, degree of soiling and washing habits of customers



Rinse

### Rinse

rinsing times settings can be selectable



Function

### Function

combination of soaking, washing, rinsing and spinning light is available



Temp.

### Temp.

Press the button to regulate the Hot, warm, cold water for wash.



Delay

### Delay

1. Select a program
2. Press the Delay button to choose the time
3. Press [Start/Pause] to commence the delay operation



On



Choose the Program



Setting time



Start

Press the [Delay] button until the Delay light is off. It should be pressed before starting the program. If the program already started, should press the [On/Off] button to reset the program.

## ⚠ Caution!

- If there is any break in the power supply while the machine is operating, a special memory stores the selected program and when the power is restarted .



FCS



ON/OFF



FCS



Start



The FCS light



### Child Lock

To avoid mis operation by children.



Power on



Start



Press Child Lock



## ⚠ Caution!

- Press the two button also to be released the function.
- The " Child Lock" will lock all buttons except [ On/Off ].

# OPERATIONS

## ■ Personalized setting of washing program

Customers can select washing program according to actual demand, and set rinsing times、water volume and appointment time

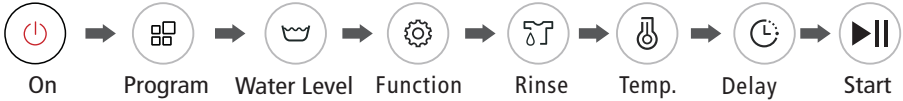

## ■ Operations of washing process

customers can set single process or combinations of washing、rinsing and spinning freely according to demand. Detailed operations as follows for different models:

### One Touch Smart Wash



### Spin



### Wash + Rinse + Spin

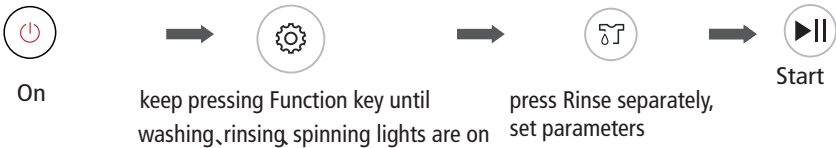

### Note!

- Note: other process combinations are just like above.

# OPERATIONS

## ■ Washing Program Table

Light Flash  
 XXXX □ XXXX  
 XXXX □ XXXX  
 XXXX □ XXXX  
 XXXX □ XXXX



Program are available according to the laundry type.  
 Only for washers having these function

Program	
Jeans:	Suitable to wash heavy stained/wearable clothes.
Quick 15':	Suitable to wash light stained clothes and clothes in summer.
Soft:	the tempo is soft, slow washing and spinning speed, to make the lightest wear and deformation.
Mix	Suitable to wash cotton ,linen ,flax. jute clothes
Normal (Standard)	Standard fabric washing program, suitable to wash ramie cotton fabric. Wash for once, rinsing for twice, the spin time is a little long.
Strong	The wash time is longer, the stream is stronger, so the washing effect is better.
Heavy	Suitable to wash heavy stained/wearable clothes.
» FCS	Start up Fast Clean System : Power on, select "Normal", "Soft", "Mix", "Strong", "Jeans" program, then press FCS button. then press "Start/Pause" button, FCS function starts up. The relative figures will be showed after FCS function starts up. Cancellation of FCS function: when the FCS function was selected, The function can be cancelled by pressing FCS button or power off.
Fuzzy weighting:	The washing machine will select the water level automatically according to the load weight. 1. When there's water in the tub, this function is not available; 2. Before press [Start/Pause] button, if consumer selected the water level, there will be no fuzzy weighting function; 3. After press [Start/Pause] button, the washing machine will run the fuzzy weighting function. Consumer can also select the water level to set the water level as needed.

# MAINTENANCE

## ■ Cleaning And Care

### ⚠ Warning!

- Before your maintenance starts, please unplug the machine and close the tap.

## ■ Cleaning the cabinet

Proper maintenance on the washing machine can extend its working life. The surface can be cleaned with diluted non-abrasive neutral detergents when necessary. If there is any water overflow, use the wet cloth to wipe it off immediately. No sharp items are allowed.

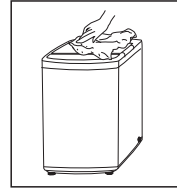

### 📌 Note!

- Formic acid and its diluted solvents or equivalent are forbidden, such as alcohol, solvents or chemical products, etc.

## ■ Cleaning the inlet filter

### 📌 Note!

- Inlet filter must be cleaned if there is less water.

Washing the filter in washing machine:

1. Screw off the inlet pipe from the backside of the machine.
2. Pull out the filter with long nose pliers and reinstall it back after being washed.
3. Use the brush to clean the filter.
4. Reconnect the inlet pipe.

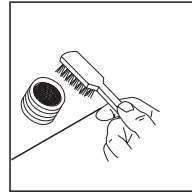
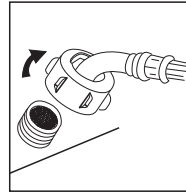

Lint filter clean

1. There is a built-in lint filter in your washer. It can help to collect lint during washing cycle.
2. It is suggested to clean the lint filter every 10 cycles.
3. Take it out and clean the filter with water. Then place it back into the washer.

magic filter

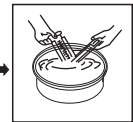
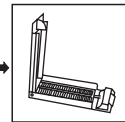

normal filter

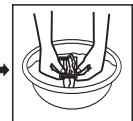
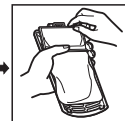

# MAINTENANCE

## ■ Cleaning drain pump filter

Only for washers having these function.

### ⚠ Warning!

- Be careful of the hot water!
- Allow detergent solution to cool down.
- Unplug the machine to avoid electrical shock before washing.
- Drain pump filter can filter the yarns and small foreign matters from the washing.
- Clean the filter periodically to ensure the normal operation of washing machine.

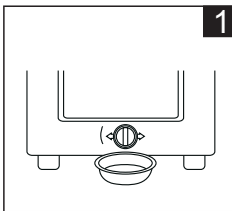

1  
Drain the water out of the pump, under which use a container to collect.

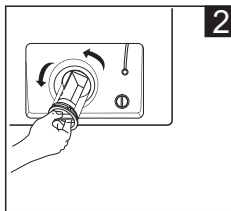

2  
Open the filter by turning to the counter clockwise

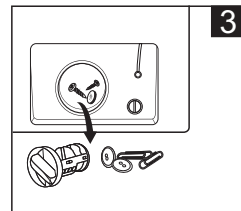

3  
Remove extraneous matter

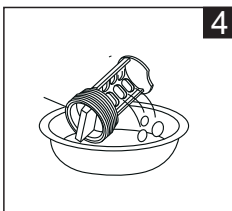

4  
Clean the filter.

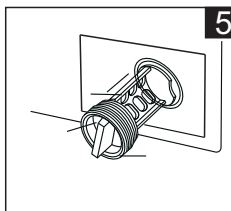

5  
Restore it and adjust the convex place to align at the pump hole.

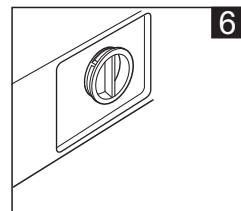

6  
Tighten the pump cover clockwise.

### ⚠ Caution!

- Make sure that valve cap and emergency drain hose are reinstalled properly, cap plates should be inserted aligning to hole plates otherwise water may leak;
- Some machines don't have emergency drain hose, so step 2 and step 3 can be skipped. Rotate lower cover cap directly to make water run into basin.
- When the appliance is in use and depending on the programme selected there can be hot water in the pump. Never remove the pump cover during a wash cycle, always wait until the appliance has finished the cycle, and is empty. When replacing the cover, ensure it is securely re-tightened.

# MAINTENANCE

## ■ Trouble Shooting

The start of the appliance does not work or it stops during operation.  
First try to find a solution to the problem, If not, contact the service centre.

Description	Inspection Items
No washing	If the power is off or the fuse is burned out. If the power supply voltage is too low. If the water amount reaches to the required water level.(The washer will not work if the water amount does not reach the required water level) If it is set to "Delay" washing mode. (It will only start to work until the reservation time reached)
No water flows in	If the power is off or the fuse is burned out. If the water supply is cut off or the water pressure is too low. If the inlet hose is properly connected and the water tap is opened. If the filtering screen of inlet valve is blocked by dirt. If the coil of inlet valve is damaged. (The slight electromagnetic sound is normal phenomenon when the inlet valve is switched on) If the "Start / Pause" button is pressed after the power switch is pressed.
Abnormal draining	If the water drain hose is placed very high. If the end of water drain hose is sealed in pond. If the internal rubber ring of drain valve is blocked by dirt.
Abnormal spin	If the door lid is closed. If all clothing piled largely at one side of barrel or the clothing is excessively placed. If the washer is not placed in stable condition or it is placed in inclination state. (The ground is not flat). If the motor belt is loosened.

Description	Reason	Solution
E1	Alarm for abnormal water intaking.	Check the water tap is opened or not.
E2	Alarm for water drain has not finished.	Check the water level sensor and drain pump.
E3	Alarm for lid not closed before wash and spin.	Close the lid, Press "Start" button
E4	Alarm for washing stay at one side.	Manually balance clothes in the barrel by hands.
EXX	Others	Please try again first, call up service line if there are still troubles

### Note!

- After the check, activate the appliance. If the problem occurs or the display shows other alarm codes again, contact the service.

# MAINTENANCE

---

## ■ Technical Information

Standard Water Pressure 0.03MPa~0.8MPa

---

Model	Washing Capacity	Dimension (W*D*Hmm)	Net Weight	Rated Power	Power Supply
WM55WT	5.5kg	515x525x910	31kg	400W	230-240V~,50Hz
WM7WT	7.0kg	550x565x935	38kg	450W	230-240V~,50Hz
WM10WT	10.0kg	601x630x1000	45kg	600W	230-240V~,50Hz



# MAINTENANCE

---

## ■ Energy efficiency test program:

WM55WT

During "Normal" Washing program, water level is 6 level, wash Temp. is warm.

WM7WT

During "Normal" Washing program, water level is 5 level, wash Temp. is warm.

WM10WT

During "Normal" Washing program, water level is 8 level, wash Temp. is warm.