

# Installation and Operating Instructions

## Country Style 900mm Gas Cooktop & Electric Oven

For your convenience, we recommend to attach the serial number label at the rear of this manual

As part of Parmco Appliances commitment to improving and updating product ranges, we reserve the right to alter, change and update technical specifications and appearance attributes of all Parmco Appliances products. E&OE.



p: 09 573 5678  
 f: 09 573 5699  
 e: sales@parmco.co.nz  
 w: www.parmco.co.nz



*Parmco Appliances  
 extended 7 year  
 warranty*

**The Warranty:**

- This appliance is intended for domestic use in the owners' home. Use of the appliance for commercial purposes will limit the warranty period (please see Parmco website for commercial details).
- Subject to the terms and conditions contained within this warranty, if the product is not of Acceptable Quality (as defined in the Consumer Guarantees Act) within 7 years of the date of original purchase, then Parmco Sales undertakes to repair or, at its sole discretion, replace the product.
- The warranty does not cover the costs of transport, mileage or travelling time if the product is located beyond 30km of a recognised Service Agent.
- This warranty is offered as an extra benefit, and does not affect other legal rights, which can not be modified or excluded by agreement.
- This warranty only applies to goods supplied and installed in the North and South Islands of New Zealand.
- The provisions of this warranty are in addition to the rights and remedies available to consumers under the Consumer Guarantees Act 1993.

Product \_\_\_\_\_ Date of purchase \_\_\_\_\_  
 Serial Number \_\_\_\_\_  
 Dealer / Retailers Name \_\_\_\_\_  
 \_\_\_\_\_

Please retain this Warranty card together with receipt or other proof of purchase date when seeking service during the warranty period

Please contact Parmco at 09 573 5678 if your appliance needs servicing under warranty. Please have your model number and proof of purchase ready. Warranty repairs must be authorized by Parmco.



**The Warranty is not valid:**

- If the product is not installed and operated in accordance with the operating instructions.
- If the product is not installed to comply with the electrical, gas, plumbing and other Regulations and Codes of Practice in New Zealand.
- If the product is operated on voltages or frequencies outside the normal range for domestic appliances in New Zealand.
- If the product is not used in normal domestic use, or if it is used in a business as defined in the Consumer Guarantees Act.
- If any serial number has been removed or defaced.
- If proof of date of purchase is not supplied, except at the sole discretion of Parmco Sales. Proof of purchase can be for the product itself, or if installed with a kitchen or house then proof of purchase can be from a Parmco reseller of products supplied by Parmco.
- If the products are purchased in a second hand condition from other parties (including but not limited to TradeMe, Sella, etc.)

**Liability under this warranty will not be accepted for:**

- Wear and tear caused by normal domestic use of the product.
- Damage in transport.
- Damage caused to the product by neglect, abuse, negligence, wilful act or misuse.
- Any costs associated with the repair, replacement, removal or reinstallation of products installed in a damaged condition.
- Any defect caused by accident, misuse, neglect, tampering with or unauthorised modifications of the appliance or any attempt at internal adjustment or repair by any person other than an Authorised Service Agent.
- Service calls that relate principally to the following:
  - Instruction on how to use the product.
  - Repair or replacement of house fuses, electrical wiring, gas fitting or plumbing.
  - Normal or scheduled maintenance including blocked filters or ducting.
  - Consumable items such as light bulbs.
  - Any damage to hobs caused by spills when cooking.
  - Any breakage or damage of glass items.
- Any damage caused by non recommended product used for cleaning, maintaining, lubricating or similar.
- Any aspect relating to the installation of the product, or damage caused during installation including blocked access for repair.
- Any third party (including reseller) or consequential loss or damage (direct or indirect) however arising.



# PARMCO

Dear Valued Customer,

Thank you and congratulations on purchasing your new Parmco appliance.

All Parmco products are made to the highest quality and design standards. We are sure you will enjoy your new appliance.

As a note, please read through these instructions carefully. These will assist you in gaining a complete understanding of the functions and features offered by your appliance. Please take special note of all detailed technical information and installation instructions. It is essential that you follow these instructions to ensure the safety and reliability of this appliance.

Furthermore, not using appropriate personnel to install this appliance may affect any future warranty claims lodged, so please check with Parmco Appliances before any installation is carried out.

We hope you enjoy your new appliance. If you would like to find out more about this product or any other products in Parmco's extensive range, visit us online at [www.parmco.co.nz](http://www.parmco.co.nz).

Regards,  
**The Parmco Team**

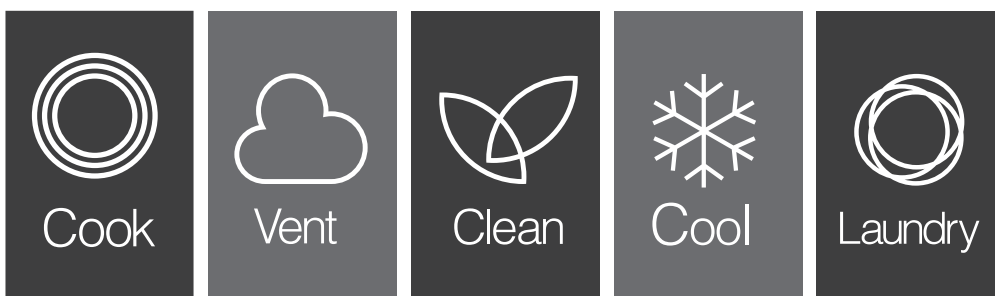



Dear User,

Our objective is to make this product provide you with the best output which is manufactured in our modern facilities in a careful working environment, in compliance with total quality concept.

Therefore, we suggest you to read the user manual carefully before using the product and, keep it permanently at your disposal.

Note: This user manual is prepared for more than one model. Some of the features specified in the Manual may not be available in your appliance.

All our appliances are only for domestic use, not for commercial use.

Products marked with (\*) are optional.

**“THIS APPLIANCE SHALL BE INSTALLED IN ACCORDANCE WITH THE REGULATIONS IN FORCE AND ONLY USED IN A WELL VENTILATED SPACE. READ THE INSTRUCTIONS BEFORE INSTALLING OR USING THIS APPLIANCE”**

## CONTENTS

Important Warnings.....	4
Introduction Of The Appliance.....	7
Important Warnings.....	8
Electrical Wiring Scheme.....	9
Gas Hose Passage Way.....	10
Installation Of Your Oven.....	11
Technical Features Of Your Oven.....	11
Injector, Gas Flow And Power Table.....	12
Reduced Gas Flow Rate Setting For Hob Taps.....	14
Reduced Flame Gas Cock Adjustment.....	14
Removal Of The Cathedral Burner.....	15
Description Of Oven.....	15
Using The Burner Groups.....	16
Using Oven Section.....	21
Cooking Time Table.....	22
Cleaning And Maintenance Of The Oven's Door.....	23
Changing The Oven Lamp.....	24
Maintenance And Cleaning.....	25
Installation Of The Oven Door.....	26
Accesories.....	27
If Your Oven Does Not Operate.....	28
Environmentally-Friendly Disposal and Package Information.....	28



## IMPORTANT WARNINGS

**1.WARNING:** To avoid electrocution, ensure that the electrical circuit of the product is open before replacing the lamp.

**2.WARNING:**Before touching the connection terminals, all supply circuit should be disconnected.

**3.WARNING:**While operating the grill, the reachable sections can be hot. Keep the children away.

**4.WARNING:**Any inadvertent cooking made with fats and oils can be dangerous and cause fire.

**5.WARNING:**Risk of fire; do not store the food materials on the cooking surface.

**6.WARNING:**If the surface is cracked, unplug the device to prevent any risk of electric shock.

**7.WARNING:**During usage the reachable sections can be hot. Keep the small children away.

**8.WARNING:**The appliance and its reachable sections become hot during usage.

**9.**The setting conditions of this appliance is indicated on the label. (Or data tag)

**10.**This appliance is not connected to a combustion product discharge system.This appliance shall be connected and installed as per the applicable installation legislation. Consider the requirements related with ventilation.

**11.**Using a gas hob will release humidity and combustion products in the room where it resides. Especially during when the appliance in use, ensure that the kitchen is well ventilated and retain the natural ventilation holes or install a mechanical ventilation system. (Hood on top of the oven) Sustained usage of the appliance may require additional ventilation. For example opening a window or if available, increasing the ventilation level of a mechanical ventilation system.

**12.**The reachable sections can become hot when the grill is used. Keep the small children away.

**13.WARNING:The appliance is intended for cooking only. It must not be used for other purposes like room heating.**

**14.**There are additional protective equipment to prevent inadvertent touching to the oven doors. This equipment should be installed if there are children.

**15.**“This appliance should be installed as per regulations and in well-ventilated location only. Read the instructions before installing or operating the appliance.”

**16.**“Before placing the appliance check the local conditions (gas type and gas pressure) and ensure that the settings of the appliance is appropriate.”

**17.**“These instructions are applicable for countries of which symbols are indicated on the appliance. If the country symbol is not available on the appliance, in order to adapt the appliance to the conditions of such country, the technical instructions should be read.”

**18.**“Do not operate the system for more than 15 seconds. If the burner does not ignite at the end of 15 seconds stop the operation of the system and open the section door and/or wait for at least 1 minute before igniting the burner.

**19.**Do not use steam cleaners to clean the appliance.

**20.**Before opening the oven door clean the remnants on it. Before closing the oven door, let it cool.

**21.**NEVER try to extinguish a fire with water, first disconnect the mains supply and then using, for example a lid or blanket, cover the fire.

**22.**Do not use hard and abrasive cleaning agents or hard metal scrapers to clean the oven door glass as they may scratch and shatter the surface.

**23.**After placing a dish, ensure that the door is firmly closed.

**24.**Unless continuous supervision is provided, the children of age 8 or below should be kept away.

**25.**Pay attention for not to touch the heating elements.

**26.**This appliance can be used by children aged from 8 years and above and persons with reduced physical, sensory or mental capabilities or lack of experience and knowledge if they have been given supervision or instruction concerning use of the appliance in a safe way and understand the hazards involved.

**27.** The appliance hasn't been designed for operation with an external timer or a separate remote control system.



## INTRODUCTION OF THE APPLIANCE

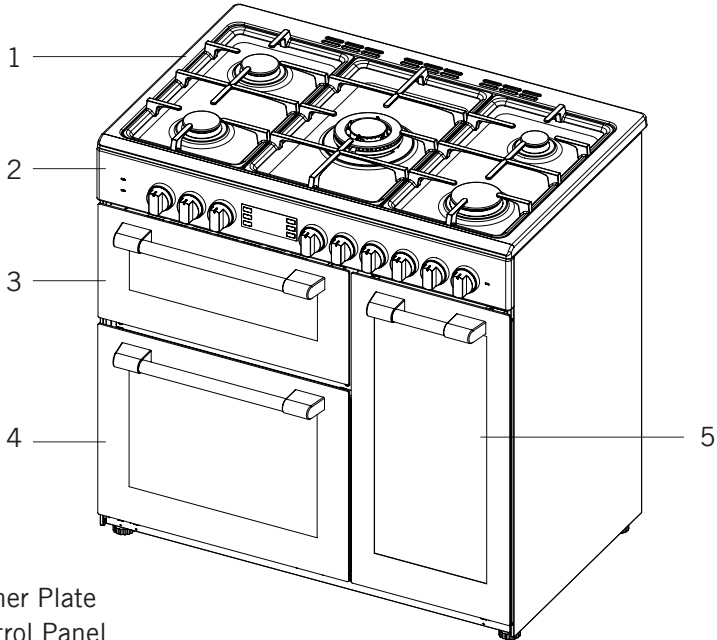

1. Burner Plate
2. Control Panel
3. LHS Grill
4. LHS Main Oven
5. RHS Oven

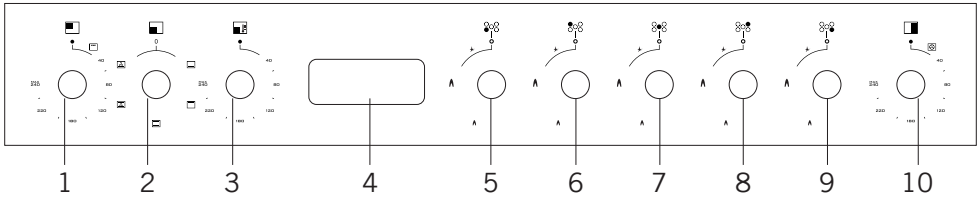

- |                             |                     |
|-----------------------------|---------------------|
| 1. LHS Grill                | 6. Normal Burner    |
| 2. LHS Main Oven            | 7. Wok Burner       |
| 3. LHS Main Oven Thermostat | 8. Auxiliary Burner |
| 4. Digital Timer*           | 9. Rapid Burner     |
| 5. Normal Burner            | 10. RHS Oven        |

**Note:** The meaning of the symbols on the control panel of device is provided below. Not every symbol is on every model; only take notice of the symbols on your device.

## IMPORTANT WARNINGS

### Electrical Connection and Security

1. Your oven requires 17 Ampere fuse according to the appliance's power. Installation by a qualified electrician is required.
2. Your oven is adjusted in compliance with 220-240V AC 50/60Hz. electric supply. If the mains are different from this specified value, contact your authorized service.
3. Electrical connection of the oven should only be made by the sockets with earth system installed in compliance with the regulations. If there is no proper socket with earth system in the place where the oven will be installed, immediately contact a qualified electrician. Manufacturer shall never be responsible from the damages that will arise because of the sockets connected to the appliance with no earth system.
4. Electrical cable should not touch the hot parts of the appliance.
5. For disconnection from the supply mains having a contact separation in all poles that provide full disconnection, must be incorporated in fixed wiring in according with the wiring rules.

### Gas Connection and Security

1. Before your appliance is connected to the gas supply, ensure that the gas category and pressure specifications shown in the data plate corresponds with your gas supply. If necessary call authorized service for adjusting to gas category.
2. This appliance shall be installed in accordance with the regulations in force and only used in a well ventilated space. Read the instructions before installing or using this appliance. In the interest of safety this appliances must be installed and / or serviced by a competent person as stated in the gas safety regulations current editions.
3. The appliance must not be installed in a room without a window or other controllable opening. If is installed in a room without a door which opens directly to the outside, a permanent opening is required. The air circulation should be  $2 \text{ m}^3/\text{h}$  per kW of burners.
4. The gas connection can be connected to either the right or left inlet. For this reason, change the hose nozzle, plug and the seals.
5. Please use flexible hose for gas connection.

6. If you make a connection with a flexible metal hose, locate a seal between the main gas pipes.

7. The inner diameter of the flexible hose, which the butane hose nozzle is connected, should be 6 mm for the house-type gas tubes. The inner diameter of the flexible hose, which the natural hose nozzle is connected, should be 15 mm. The hose should tightly be fitted to the hose nozzle by squeezing with a clamp. The hose should be replaced before its last expiry date.

8. Caution! Make the oven connection to the gas inlet valve, the hose length must be short and be sure that there is no leakage. The flexible hose used should not be longer than 125 cm for safety.

9. Re-inspect the gas connection.

10. When placing your oven to its location, ensure that it is at the counter level. Bring it to the counter level by adjusting the feet if necessary.

**DO NOT MAKE GAS HOSE AND ELECTRICAL CABLE OF YOUR OVEN GO THROUGH THE HEATED AREAS, ESPECIALLY THROUGH THE REAR SIDE OF THE OVEN. DO NOT MOVE GAS CONNECTED OVEN. SINCE THE FORCING SHALL LOOSEN THE HOSE, GAS LEAKAGE MAY OCCUR.**

## ELECTRICAL WIRING SCHEME

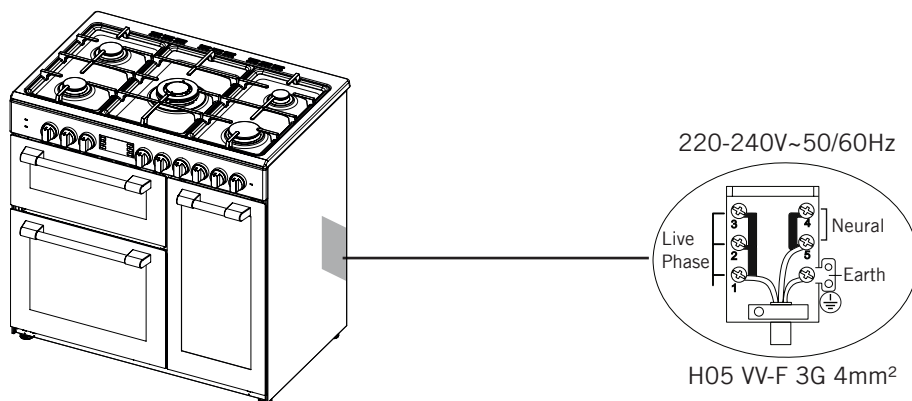

## GAS HOSE PASSAGE WAY

1. Connect the appliance to the gas piping tap in shortest possible route and in a way that ensure no gas leakage will occur.
2. In order to carry on a tightness and sealing safety check ensure that the knobs on the control panel are closed and the gas cylindir is open.
3. While performing a gas leakage check, never use any kind of lighter, match, cigarette or similar burning substance.
4. Apply soap bubble on the connection points. If there is any kind of leakage then it will cause bubbling.
5. While inserting the appliance in place ensure that it is on the same level with the worktop. If required adjust the legs inorder the make level with the worktop.
6. Use the appliance on a level surface and in a well ventilated environment.

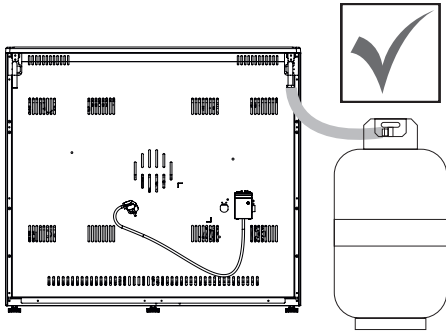

Figure 1

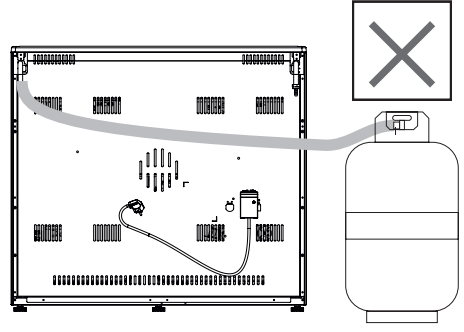
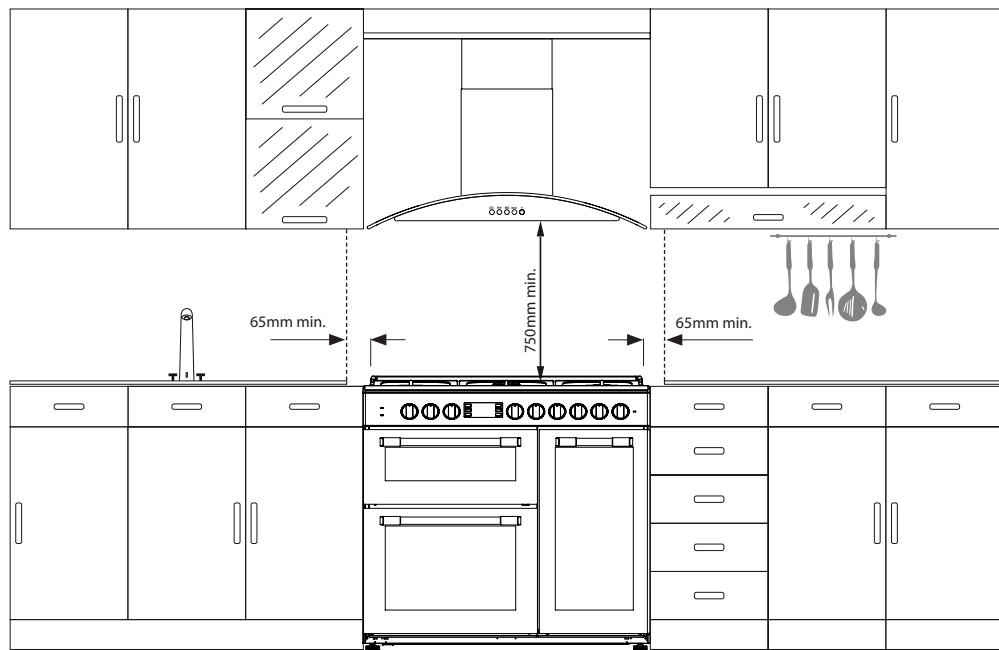

Figure 2

## INSTALLATION OF YOUR OVEN



## TECHNICAL FEATURES OF YOUR OVEN

Outer width	900mm		
Outer depth	600mm		
Outer height	900mm		
Lamp power	15-25W		
	Grill Oven	Main Oven	RHS
Bottom heating element	---	1200W	---
Top heating element	---	1000W	---
Turbo heating element	---	1800W	1800W
Grill heating element	1400W	---	---
Supply voltage	220-240V AC 50/60Hz		
Total electrical consumption	Type code	MFR0/9501203G	1840W
	Type code	MFR0/9502103E	5500W
Total gas consumption	Type code	MFR0/9501203G	14,25 kW, 1036 g/h
	Type code	MFR0/9502103E	10,75 kW, 782 g/h

**RANGE COOKER  
INJECTOR, GAS FLOW And POWER TABLE**

BURNER SPECIFICATIONS	G20,20 mbar G25,25 mbar			G20,25 mbar	
	Gas Natural			Gas Natural	
Wok Burner	Injector	1,40	mm	1,28	mm
	Gas Flow	0,333	m <sup>3</sup> /h	0,333	m <sup>3</sup> /h
	Power	3,50	kW	3,50	kW
Rapid Burner	Injector	1,15	mm	1,10	mm
	Gas Flow	0,276	m <sup>3</sup> /h	0,276	m <sup>3</sup> /h
	Power	2,90	kW	2,90	kW
Semi-Rapid Burner	Injector	0,97	mm	0,92	mm
	Gas Flow	0,162	m <sup>3</sup> /h	0,162	m <sup>3</sup> /h
	Power	1,70	kW	1,70	kW
Auxiliary Burner	Injector	0,72	mm	0,70	mm
	Gas Flow	0,96	m <sup>3</sup> /h	0,96	m <sup>3</sup> /h
	Power	0,95	kW	0,95	kW
Grill Burner	Injector	0,92	mm	0,92	mm
	Gas Flow	0,144	m <sup>3</sup> /h	0,144	m <sup>3</sup> /h
	Power	1,50	kW	1,50	kW
Main Oven	Injector	0,97	mm	0,97	mm
	Gas Flow	0,190	m <sup>3</sup> /h	0,190	m <sup>3</sup> /h
	Power	2,00	kW	2,00	kW

**RANGE COOKER**  
**INJECTOR, GAS FLOW And POWER TABLE**

BURNER SPECIFICATIONS	G30,28-30 mbar G31,37 mbar			G30,50 mbar		G30,37 mbar	
	LPG			LPG		LPG	
Wok Burner	Injector	0,96	mm	0,76	mm	0,96	mm
	Gas Flow	254	g/h	254	g/h	254	g/h
	Power	3,50	kW	3,50	kW	3,50	kW
Rapid Burner	Injector	0,85	mm	0,75	mm	0,85	mm
	Gas Flow	211	g/h	211	g/h	211	g/h
	Power	2,90	kW	2,90	kW	2,90	kW
Semi-Rapid Burner	Injector	0,65	mm	0,60	mm	0,65	mm
	Gas Flow	124	g/h	124	g/h	124	g/h
	Power	1,70	kW	1,70	kW	1,70	kW
Auxiliary Burner	Injector	0,50	mm	0,43	mm	0,50	mm
	Gas Flow	69	g/h	69	g/h	69	g/h
	Power	0,95	kW	0,95	kW	0,95	kW
Grill Burner	Injector	0,60	mm	0,55	mm	0,60	mm
	Gas Flow	109	g/h	109	g/h	109	g/h
	Power	1,50	kW	1,50	kW	1,50	kW
Main Oven	Injector	0,70	mm	0,65	mm	0,70	mm
	Gas Flow	131	g/h	131	g/h	131	g/h
	Power	2,00	kW	2,00	kW	2,00	kW

## REDUCED GAS FLOW RATE SETTING FOR HOB TAPS

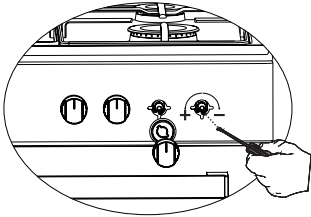

Figure 3

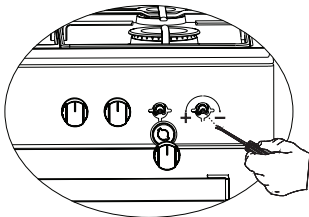

Figure 4

1. Ignite the burner that is to be adjustment and turn the knob to the reduced position.
2. Remove the knob from the gas tap.
3. Use an appropriately sized screwdriver to adjust the flow rate adjustment screw. For LPG (Butane-Pro pane) turn the screw clockwise. For the naturel gas, you should turn the screw counter- clockwise once.

“The normal length of a straight flame in the reduced position should be 6-7 mm.”

4. If the flame is higher then the desired position, turn the screw clockwise. If it is smaller turn anticlockwise.
5. For the last control, bring the burner both to high-flame and reduced positions and check whether the flame is on or off.

Depending on the type of gas tap used in your appliance the adjustment screw position may vary.

To adjust your oven acc. to the gas type, make the adjustment for reduced flame carefully by turning with a small screwdriver as shown below on the screw in the middle of the gas cocks as well as nozzle changes. (Figure 3 and 4)

## REDUCED FLAME GAS COCK ADJUSTMENT

1. Please use driver with special head for removed and install nozzle as (Figure 5).
2. Please remove nozzle (Figure 6) from burner with special nozzle driver and install new nozzle. (Figure 7)



Figure 5

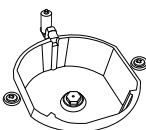

Figure 6

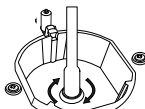
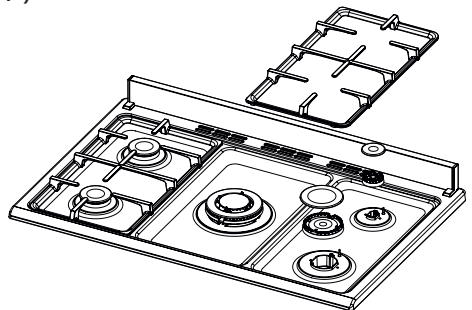

Figure 7





## REMOVAL OF THE CATHEDRAL BURNER

The burner protection sheet is fixed with two screws. As shown in Figure 8, use a screwdriver to remove it. As shown in Figure 9, press the spring clip in the direction of the arrow to remove the burner from the slot. As shown in Figure 10, remove the injector in the bearing with a socket wrench. In order to re-place the burner, apply the removal process reversely.

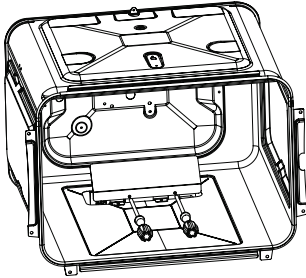

Figure 8



Figure 9

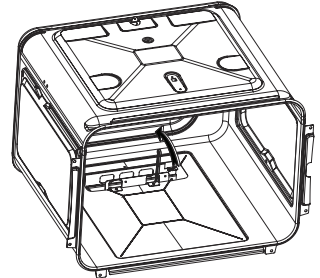











Figure 10

## DESCRIPTION OF OVEN

	Top + Bottom heating element		Turbo heating + Fan
	Bottom heating element + Fan		Bottom + Top heating elements + Fan
	Grill burner / Grill heating element		Top heating element
	Oven burner / Bottom heating element		Flame
	Ignition Lighter		

**THERMOSTAT KNOB;** In order to operate the oven, thermostat must be adjusted to desired temperature. Your thermostat has a feature of adjustment to 40 - 240 degree.

## USING THE BURNER GROUPS

1. ● Closed 🔥 Fully open 🔥 Half open

2. If your oven has ignition system from push button switch please press and turn gas valve open position and same time press ignition button.

3. Each burner has it's own knob.

When you want to use your preferred burner, you must press the knob and wait nearly 3-5 second. Then you can ignite it through the automatic ignition system (optional) or match. You must wait 10-15 second after ignited to release the knob.

4. The knobs controlling the gas cookers have special mechanism. In order to light the cooker;

5. Always press on the switch forward and bring it to flame symbol by turning anticlockwise (left). All of the lighters shall operate and the cooker you controlled shall light only. Keep the switch pressed until ignition is performed.

6. In models with security system, when flame of the cooker is extinguished, control valve cuts off the gas automatically. For operate the burners with gas security system you must make press the knob and turn antilock wise. After the ignition (with optional automatic ignition system or match) you must wait nearly 5-10 second for gas security systems activation.

7. Do not continuously operate the igniter for more than 15 seconds. After 15 seconds, if the burner does not ignite, then stop and if you are trying to ignite the oven then open the door and wait a minimum of one minute before trying again. If the burner is extinguished for of the any reason, close the gas control valve and wait a minimum of one minute before trying again.

8. Before operating your hob please make sure that the burner caps are well positioned. The right placement of the burner caps are shown as below.

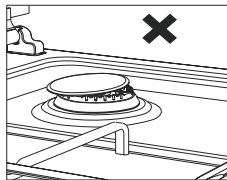

Figure 11

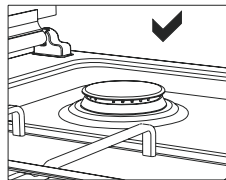
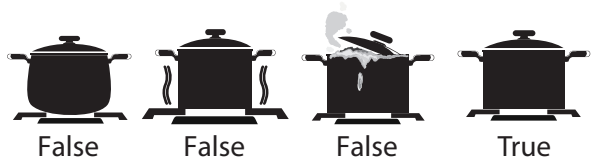

Figure 12

## Pot Diameter

WOK Burner	26-32cm
Big Burner	22-26cm
Normal Burner	18-22cm
Small Burner	12-18cm



## Gas Connection and Safety

1. For LPG (cylinder) connection, affix metal clamp on the hose coming from LPG cylinder. Affix an edge of the hose on hose inlet connector behind the appliance by pushing to end through heating the hose in boiled water. Afterward, bring the clamp towards end section of the hose and tighten it with screwdriver. The gasket and hose inlet connector required for connection is as the picture shown below.

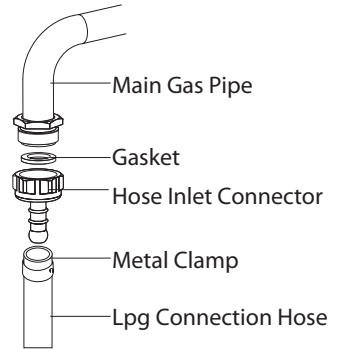

**NOTE:** The regulator to be affixed on LPG cylinder should have 300 mmSS feature.

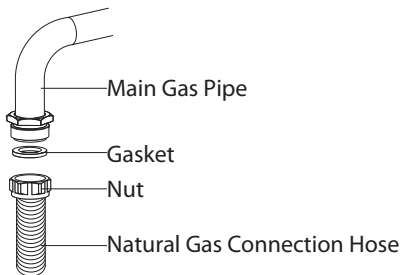

2. Natural gas connection should be done by authorized service. For natural gas connection, place gasket in the nut at the edge of natural gas connection hose. To install the hose on main gas pipe, turn the nut. Complete the connection by making gas leakage control.



Gas hose and electric connection of the appliance should not pass next to hot areas such as back of the appliance. Gas hose should be connected by making wide angle turns against breaking possibility. Movement of appliance whose gas connection is made may cause gas leakage.

Installation of the appliance and its connection to the electrical mains must only be carried out by **QUALIFIED PERSONNEL**.

## United Kingdom Type Gas Connection:

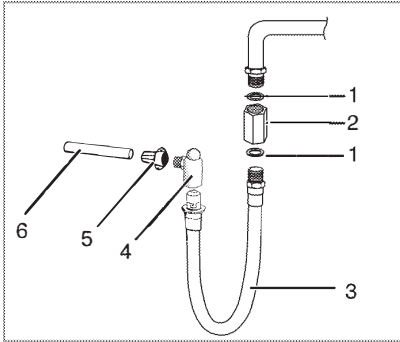

1. Gasket
2. Adapter
3. Gas (safety) hose
4. Valve with 90° outlet
5. Connection piece
6. Gas supply pipe

**WARNING:** The gas hose must not be clamped, bent or trapped or come into contact with hot parts of the product. There is the risk of explosion due to damaged gas hose.

### Ventilation Of Room

The air needed for burning is received from room air and the gases emitted are given directly in room. For safe operation of your product, good room ventilation is a precondition. If no window or room to be utilized for room ventilation is available, additional ventilation should be installed. However, room has a door opening outside, it is not needed to vent holes.

Room Size	Ventilating Opening
Smaller than 5m <sup>3</sup>	min. 100cm <sup>2</sup>
Between 5m <sup>3</sup> - 10m <sup>3</sup>	min. 50cm <sup>2</sup>
Bigger than 10m <sup>3</sup>	no need
In basement or cellar	min. 65cm <sup>2</sup>

## Using The Hobs

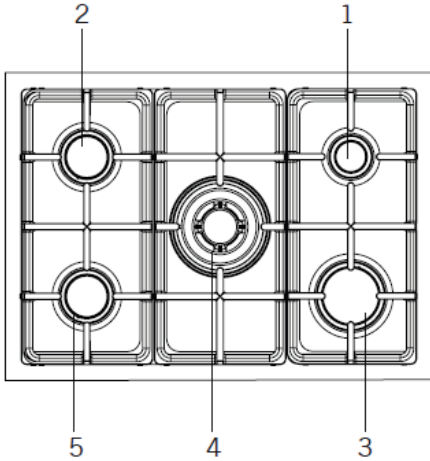

1. Auxiliary Burner
2. Normal Burner
3. Rapid Burner
4. Wok Burner
5. Normal Burner

Large flame symbol indicates the highest cooking power and small flame symbol indicates the lowest cooking power. In turned off position (top), gas is not supplied to the burners.

### Gas Breaking Safety Appliance

Against putting out to be taken place as a result of liquid overflow at upper burners, safety appliance steps in and cut gas immediately.

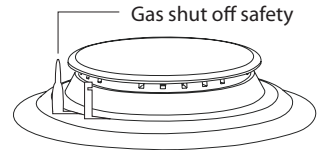

Figure 13

### Wok Burner

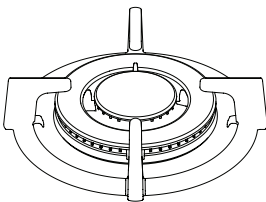

Figure 14

As it possesses double ring flame system, it gives homogenous heat distribution at the bottom of cooking pot at high temperature. It is ideal for short term and high temperature cooking. When you want to use regular cooking pot on wok burner, it is necessary that you remove wok cooking pot carrier from oven.

## Using multi-segmented cooking zones

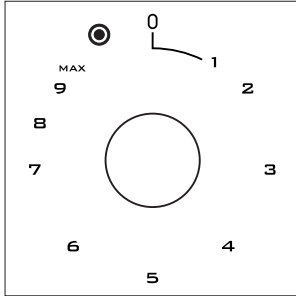
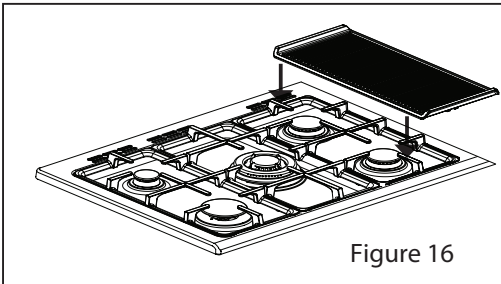

Figure 15

Multi segmented cooking zones allows to cook with different size of saucepans on the same cooking zone. When these cooking zones are activated, first the inward cooking zone turns on.

1. To change the active cooking zone diameter, turn the control knob clockwise.
2. A "click" will be heard as soon as the hotplate radius changes.

## Griddle\*



Ensure the griddle placed to pins on burner plate. Griddle becomes very hot while it is in use. Keep children away from the oven. Used to cook your food directly. Warning: Place the griddle only onto marked area.

1. Metal utensils such as spatulas can damage the cooking surface.
2. Do not place the griddle horizontally onto the hob. It will not fit properly and may fall from the top of the hob.
3. Heat the griddle for max. 2 minutes before putting food on it. It may get damaged if it is heated for longer.

Warning: cast iron, griddle is heavy. Be careful during handling.

## USING OVEN SECTION

1. When your oven is operated first time, an odor will be spread out which will be sourced from using the heating elements. In order to get rid of this, operate it for 45 minutes while it is empty. In order to make cooking in your oven; oven switch must have been rotated and ignition must have been made. Otherwise, your oven will not run.

2. Kinds of meals you will cook, cooking times and Thermostat positions (Optional) were given in cooking table. The values given in the cooking table are characteristic values and were obtained as a result of the tests performed in our laboratory. You can find different flavors suitable for your taste depending on your cooking and using habits.

3. Cooking times: The results may change according to the local voltage and material having different quality, amount, and temperatures.

4. During the time when cooking is being performed in the oven, the door of the oven shouldn't be opened frequently. Otherwise circulation of the heat may be imbalanced and the results may change.

### Rack Positions (for models with wire shelf)

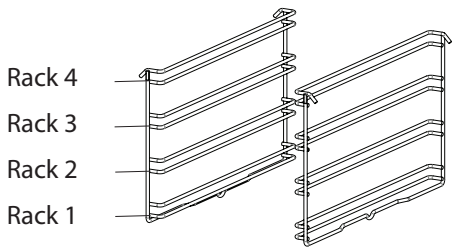

Figure 17

It is important to place the wire shelf onto the side rack correctly. Wire shelf must be inserted between the side racks as illustrated in the figure. Do not let the wire shelf stand against the rear wall of the oven.

Slide your wire shelf to the front section of the rack and settle it with the help of the door in order to obtain a good grill performance.

## Catalytic Walls\*

Catalytic walls are located on the left and the right side of cavity under the guides. Catalytic walls banish the bad smell and obtain the best performance from the cooker. Catalytic walls also absorb oil residue and clean your oven while it's operating.

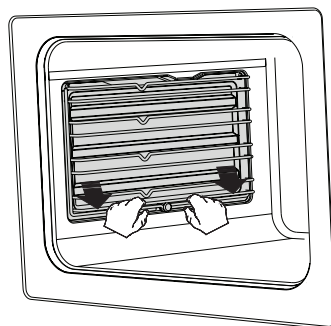

Figure 18

### Removing the catalytic walls

In order to remove the catalytic walls; the guides must be pulled out. As soon as the guides are pulled out, the catalytic walls will be released automatically. The catalytic walls must be changed after 2-3 years.

## COOKING TIME TABLE

**WARNING:** Oven must be preheated for 7-10 minutes before placing the food in it.

Foods	Oven Cavity	Rack Position	Cooking Function	Temperature (°C)	Cooking Duration (min.)
* Cookie	Right Cavity	2-4-6-8	Turbo Fan	170-180	30-35
** Pizza	Right Cavity	2-4-6-8	Turbo Fan	200-240	20-25
Tray Cake	Left Bottom	2	Static	170-180	35-40
Pastry	Left Bottom	2	Static	170-180	30-35
*** Steak	Left Bottom	2	Grill	Max.	30-35
Quiche Lorraine	Left Bottom	2	Turbo Fan	170-180	30-35
Tray Patty	Left Bottom	2	Static	180-200	30-35
Apple Pie	Left Bottom	2	Static	180-190	60-65
Small Cake	Left Bottom	2	Static	170-180	25-30

\* It is possible to cook up to at max.4 shelves at the same time by laying oily paper on the gril, at half of cooking time, change cookies between 2-4 and 6-8 shelves.

\*\* It is possible to cook up to at max.4 shelves at the same time, at half of cooking time, change pizzas between 2-4 and 6-8 shelves.

\*\*\* Food must be turned after half of the cooking time.



## CLEANING AND MAINTENANCE OF THE OVEN'S DOOR

### Drop-Down Door Glass

Remove the profile by pressing the plastic latches on both left and right sides as shown in Figure 19 and pulling the profile towards yourself as shown in Figure 20 Then remove the inner-glass as shown in Figure 21 If required, middle glass can be removed in the same way. After cleaning and maintenance are done, remount the glasses and the profile in reverse order. Make sure the profile is properly seated in its place.

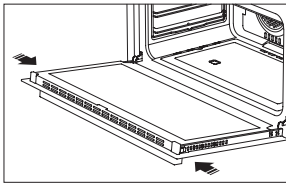

Figure 19

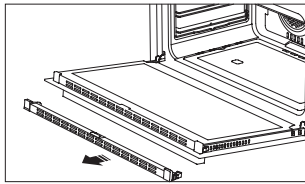

Figure 20

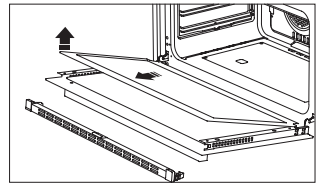

Figure 21

### Side Opening Door Glass

Open the door glass. Remove the glass by pulling upward. The outer glass is fixed to the oven door profile. After removing the glass, cleaning can be done easily. After determining procedures for cleaning and maintenance, please put the glass by pushing down. Make sure the glass is well installed.

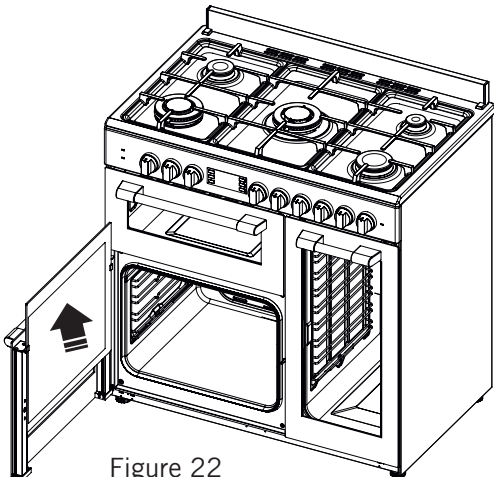

Figure 22

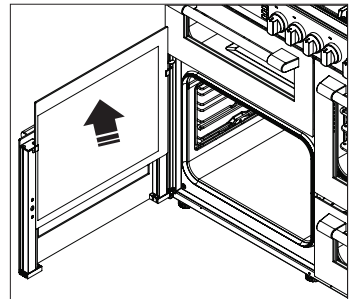

Figure 22.1

## CHANGING THE OVEN LAMP

In order to avoid the possibility of an electric shock, ensure that the circuit of the appliance is open before changing the lamp. (The open-circuit is an electrical circuit that does not conduct current)

1. First of all, cut the electrical connection of the appliance and ensure that the appliance is cooled down.
2. Remove the glass protection by turning as shown in the figure. If you have difficulty in turning it, the use of plastic gloves will help you.
3. Afterwards, remove the lamp by turning and install the new lamp with the same specifications.
4. Place the glass protection and complete the replacing process by plugging in the electric cable of the appliance. Now, you can use your oven.

### Type G9 Lamp Assembly:

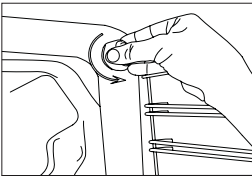

220-240 V, AC  
15-25 W

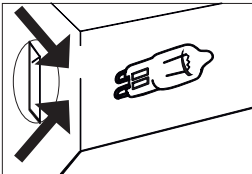
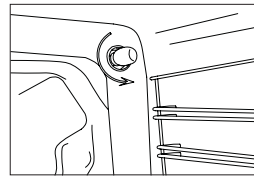

Figure 23

### Type E14 Lamp Assembly:



220-240 V, AC  
15 W

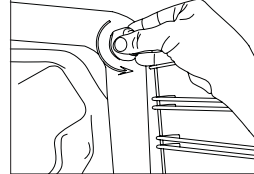

Figure 24

## MAINTENANCE and CLEANING

1. Disconnect the plug supplying electricity for the oven from the socket.
2. While oven is operating or shortly after it starts operating, it is extremely hot. You must avoid touching from heating elements.
3. Never clean the interior part, panel, lid, trays and all other parts of the oven by the tools like hard brush, cleaning mesh or knife. Do not use abrasive, scratching agents and detergents.
4. After cleaning the interior parts of the oven with a soapy cloth, rinse it and then dry thoroughly with a soft cloth.
5. Clean the glass surfaces with special glass cleaning agents.
6. Do not clean your oven with steam cleaners.
7. Before opening the upper lid of the oven, clean spilled liquid off the lid. Also, before closing the lid, ensure that the cooker table is cooled enough.
8. Never use inflammable agents like acid, thinner and gasoline when cleaning your oven.
9. Do not wash any part of your oven in dishwasher.
10. In order to clean the front glass lid of the oven; remove the fixing screws fixing the handle by means of a screwdriver and remove the oven door. Then clean and rinse it thoroughly. After drying, place the oven glass properly and re-install the handle.

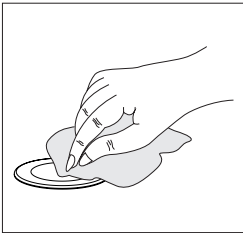

Figure 25

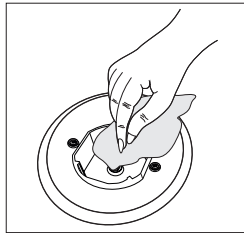

Figure 26

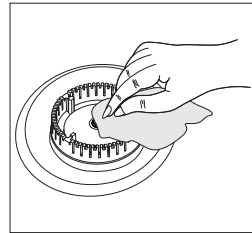

Figure 27

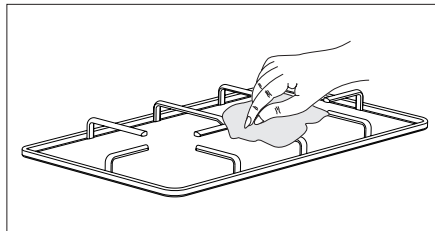

Figure 28

## INSTALLATION OF THE OVEN DOOR

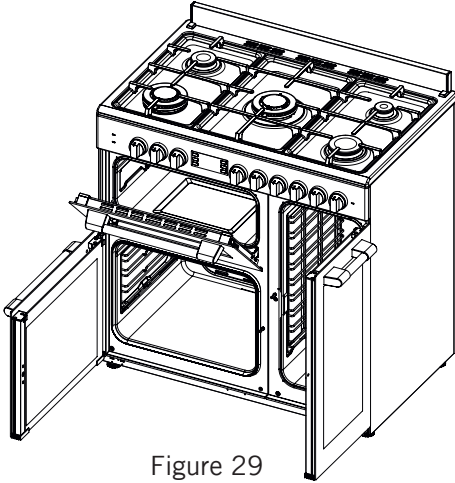

Figure 29

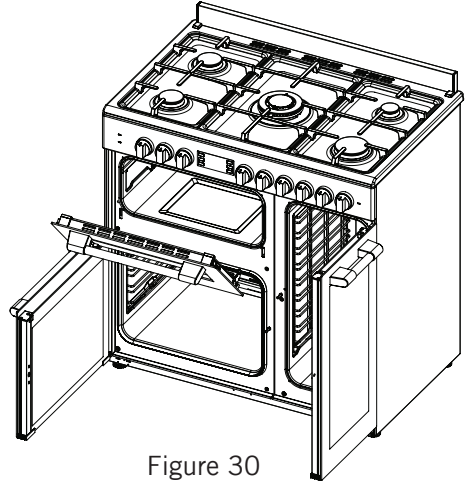

Figure 30

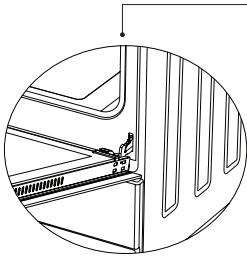

Figure 29.1

Completely open the oven door by pulling it to yourself. Afterwards, perform the unlocking process by pulling the hinge lock upwards with the help of a screw driver as shown in **Figure 29.1**.

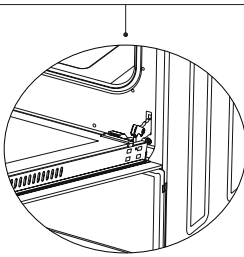

Figure 29.2

Bring the hinge lock to the widest angle as shown in **Figure 29.2**. Bring both hinges connecting the oven door to the oven to the same position.

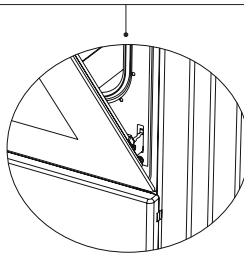

Figure 30.1

Afterwards, close the oven door as to lean on the hinge lock as shown in **Figure 30.1**.

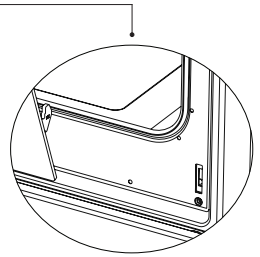
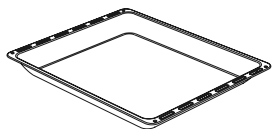

Figure 30.2

To remove the oven door, pull it upwards by holding it with both hands when close to the closed position as shown in **Figure 30.2**.

In order to re-place the oven door, perform the abovementioned steps in reverse.

## ACCESSORIES



### Deep Tray\*

Used for pastries, deep fried foods and stew recipes. In case of frying directly on the grill for cakes, frozen foods and meat dishes, it can be used of oil pick-up tray.

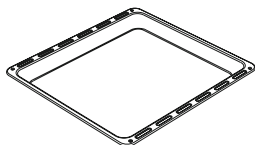

### Tray

Used for pastries (cookies, biscuits etc.) and frozen foods.



### Wire Grill

Used for frying and/or placing the foods to be baked, fried and frozen foods on the desired rack.



### In Tray Wire Grill\*

Foods that can stick while cooking such as beef are placed on in tray grill. Thus, the contact and sticking of the food is prevented.

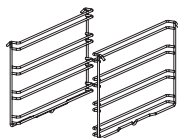

### Lower and Upper Wire Racks

While cooking, you can place the deep tray and tray on the lower and upper wire racks.

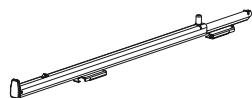

### Telescopic Rail\*

With the help of telescopic rails, the trays and/or wire racks can be easily placed and removed.



### Splash Back\*

The resulting temperature of the oven chimney avoid contact with the wall.

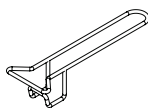

### Tray Handle

Use for hot tray.



### Coffee Pot Support Unit\*

Can be used for coffee pot.

## IF YOUR OVEN DOES NOT OPERATE

1. Please check main gas valve.
2. Gas hose is can be broken or bend.
3. Please check the connection of gas hose with oven.
4. Please check noise of gas rate.
5. Please check the gas valve, suitable or unsuitable for your oven.
6. If you can not to solve the problem, to apply manufacturer-supplier services agent or similar qualified persons.
7. We are recommended per 2 year chance your ovens gas valve.
8. Please check the plug of power supply cord has a well connection with wall socket or not.
9. Please check the electric network.
10. Please check the fuse.
11. Please check power supply cord for any damage problems.

## ENVIRONMENTALLY-FRIENDLY DISPOSAL

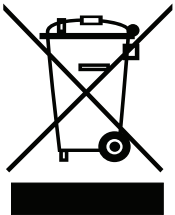

Dispose of packaging in an environmentally-friendly manner.

This appliance is labelled in accordance with European Directive 2012/19/EU concerning used electrical and electronic appliances (waste electrical and electronic equipment - WEEE). The guideline determines the frame work for the return and recycling of used appliances as applicable throughout to the EU.

## PACKAGE INFORMATION

Packaging materials of the product are manufactured from recyclable materials in accordance with our National Environment Regulations. Do not dispose of the packaging materials together with the domestic or other wastes. Take them to the packaging material collection points designated by the local authorities.