

# Installation and Operating Instructions

**Model:**

**PD45-SLIM-SS-1**

**PD45-SLIM-W-1**

**PD45-SLIM-SS-2**

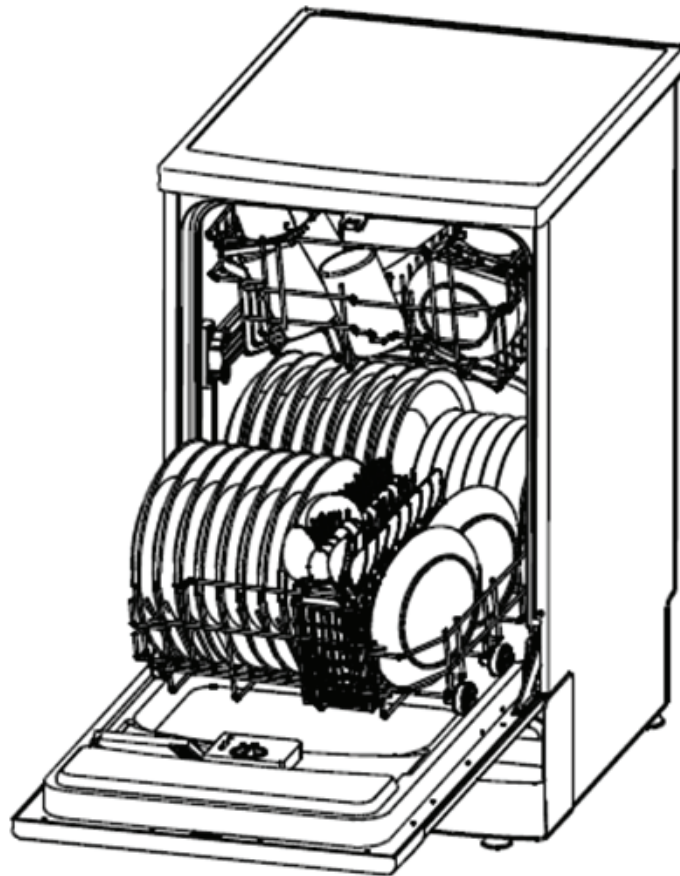

As part of Parmco Appliances commitment to improving and updating product ranges, we reserve the right to alter, change and update technical specifications and appearance attributes of all Parmco Appliances products. E&OE.



p: 09 573 5678  
 f: 09 573 5699  
 e: sales@parmco.co.nz  
 w: www.parmco.co.nz



# Parmco Appliances extended 7 year warranty

## The Warranty:

- This appliance is intended for domestic use in the owners' home. Use of the appliance for commercial purposes will limit the warranty period (please see Parmco website for commercial details).
- Subject to the terms and conditions contained within this warranty, if the product is not of Acceptable Quality (as defined in the Consumer Guarantees Act) within 7 years of the date of original purchase, then Parmco Sales undertakes to repair or, at its sole discretion, replace the product.
- The warranty does not cover the costs of transport, mileage or travelling time if the product is located beyond 30km of a recognised Service Agent.
- This warranty is offered as an extra benefit, and does not affect other legal rights, which can not be modified or excluded by agreement.
- This warranty only applies to goods supplied and installed in the North and South Islands of New Zealand.
- The provisions of this warranty are in addition to the rights and remedies available to consumers under the Consumer Guarantees Act 1993.

Product \_\_\_\_\_ Date of purchase \_\_\_\_\_  
 Serial Number \_\_\_\_\_  
 Dealer / Retailers Name \_\_\_\_\_  
 \_\_\_\_\_

Please retain this Warranty card together with receipt or other proof of purchase date when seeking service during the warranty period

Please contact Parmco at 09 573 5678 if your appliance needs servicing under warranty. Please have your model number and proof of purchase ready. Warranty repairs must be authorized by Parmco.



## The Warranty is not valid:

- If the product is not installed and operated in accordance with the operating instructions.
- If the product is not installed to comply with the electrical, gas, plumbing and other Regulations and Codes of Practice in New Zealand.
- If the product is operated on voltages or frequencies outside the normal range for domestic appliances in New Zealand.
- If the product is not used in normal domestic use, or if it is used in a business as defined in the Consumer Guarantees Act.
- If any serial number has been removed or defaced.
- If proof of date of purchase is not supplied, except at the sole discretion of Parmco Sales. Proof of purchase can be for the product itself, or if installed with a kitchen or house then proof of purchase can be from a Parmco reseller of products supplied by Parmco.
- If the products are purchased in a second hand condition from other parties (including but not limited to TradeMe, Sella, etc.)

## Liability under this warranty will not be accepted for:

- Wear and tear caused by normal domestic use of the product.
- Damage in transport.
- Damage caused to the product by neglect, abuse, negligence, wilful act or misuse.
- Any costs associated with the repair, replacement, removal or reinstallation of products installed in a damaged condition.
- Any defect caused by accident, misuse, neglect, tampering with or unauthorised modifications of the appliance or any attempt at internal adjustment or repair by any person other than an Authorised Service Agent.
- Service calls that relate principally to the following:
  - Instruction on how to use the product.
  - Repair or replacement of house fuses, electrical wiring, gas fitting or plumbing.
  - Normal or scheduled maintenance including blocked filters or ducting.
  - Consumable items such as light bulbs.
  - Any damage to hobs caused by spills when cooking.
  - Any breakage or damage of glass items.
  - Any damage caused by non recommended product used for cleaning, maintaining, lubricating or similar.
- Any aspect relating to the installation of the product, or damage caused during installation including blocked access for repair.
- Any third party (including reseller) or consequential loss or damage (direct or indirect) however arising.



# PARMCO

Dear Valued Customer,

Thank you and congratulations on purchasing your new Parmco appliance.

All Parmco products are made to the highest quality and design standards. We are sure you will enjoy your new appliance.

As a note, please read through these instructions carefully. These will assist you in gaining a complete understanding of the functions and features offered by your appliance. Please take special note of all detailed technical information and installation instructions. It is essential that you follow these instructions to ensure the safety and reliability of this appliance.

Furthermore, not using appropriate personnel to install this appliance may affect any future warranty claims lodged, so please check with Parmco Appliances before any installation is carried out.

We hope you enjoy your new appliance. If you would like to find out more about this product or any other products in Parmco's extensive range, visit us online at [www.parmco.co.nz](http://www.parmco.co.nz).

Regards,

**The Parmco Team**



Cook



Vent



Clean



Cool



Laundry

<b>Content</b>	<b>Page</b>
<b>Important Safety Information</b>	<b>3</b>
<b>Product Description</b>	<b>6</b>
<b>Use and Care</b>	<b>7</b>
<b>Washing Cycles</b>	<b>15</b>
<b>Cleaning and Maintenance</b>	<b>17</b>
<b>Installation</b>	<b>20</b>
<b>Troubleshooting Tips</b>	<b>23</b>
<b>Technical Information</b>	<b>26</b>



### **IMPORTANT NOTE**

It is the law in New Zealand that this appliance must be installed by authorised persons. The installation must comply with all the appropriate New Zealand Standards and Regulatory Requirements with particular reference to the New Zealand Electrical Standards.

Any attempt to install this or any other Parmco product without an authorised person could result in damage to the product and a possible health hazard. Not having an authorised person install this appliance may result in all associated warranties from Parmco Appliances being null and void.

# IMPORTANT SAFETY INFORMATION

We recommend that for best performance and to extend the life of your appliance you read the instructions in this owner's manual thoroughly before using your new appliance. It will provide you with all the information you need to ensure its safe installation, proper use and maintenance. Retain this owner's manual for future reference.



Before Calling for Service:

- To review the section on troubleshooting Tips will help you to solve some common problems by yourself.
- If you cannot solve the problems by yourself, please ask for the help of professional technicians.



Note: The manufacturer, following a policy of constant development and updating of the product, may make modifications without giving prior notice.



Warning! When using your dishwasher, follow the precautions listed below:



## **WARNING! HYDROGEN GAS IS EXPLOSIVE**

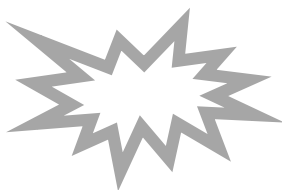

Under certain conditions Hydrogen gas may be produced in a hot-water system that has not been used for two weeks or more. **HYDROGEN GAS IS EXPLOSIVE.** If the hot-water system has not been used for such a period of time, before using the dishwasher turn on all the hot-water taps and let the water flow from each of them for several minutes. This will release any accumulated hydrogen gas. As the gas is flammable, do not smoke or use an open flame during this time.



## **GROUNDING INSTRUCTIONS**

- This appliance must be grounded. In the event of a malfunction or breakdown, grounding will reduce the risk of electric shock by providing a path of least resistance of electric current. This appliance is equipped with a cord having an equipment-grounding conductor and grounding plug.
- The plug must be plugged into an appropriate outlet that is installed and grounded in accordance with all local codes and ordinances.



## **WARNING!**

- Improper connection of the equipment-grounding conductor can result in the risk of an electric shock.
- Check with a qualified electrician or service representative if you are in doubt whether the appliance is properly grounded. Do not modify the plug provided with the appliance; if it does not fit the outlet. Have a proper outlet installed by a qualified electrician.



## **WARNING! PROPER USE**

- Do not abuse, sit on, or stand on the door or dish baskets of the dishwasher.
- Do not operate your dishwasher unless all enclosure panels are properly in place.
- Open the door very carefully if the dishwasher is operating. There is a risk of water squirting out.
- Do not place any heavy objects or stand on the door when it is open. The appliance could tip forward.
- When loading items to be washed:
  - Locate sharp items so that they are not likely to damage the door seal;
  - Load sharp knives with the handles up to reduce the risk of cut-type injuries;
  - Warning: Knives and other utensils with sharp points must be loaded in the basket with their points down or placed in a horizontal position.
- Check that the detergent dispenser is empty after completion of the wash cycle.
- Do not wash plastic items unless they are marked dishwasher safe or the equivalent. For plastic items not so marked, check the manufacturer's recommendations.
- Use only detergent and rinse additives designed for an automatic dishwasher. Never use soap, laundry detergent, or hand washing detergent in your dishwasher.
- Keep children away from detergent and rinse aid, keep children away from the open door of the dishwasher, there could still be some detergent left inside.
- To protect against the risk of electrical shock, do not immerse the unit, cord or plug in water or other liquid.
- This appliance must only be used by adults. Make sure that children do not touch the controls or play with the appliance. Young children should be supervised to ensure they do not play with the appliance.
- This appliance is not intended for use by persons (including children) with reduced physical, sensory, mental capabilities, or lack of experience and knowledge, unless they have been given supervision or instruction concerning the use of this appliance by a person responsible for their safety.
- Dishwasher detergents are strongly alkaline. They can be extremely dangerous if swallowed.
- Avoid contact with skin and eyes, and keep children away from the dishwasher when the door is open.
- The door should not be left in the open position since this could present a tripping hazard.
- If the supply cord is damaged, it must be replaced by the manufacturer or its service agent or a similarly qualified person in order to avoid a hazard.
- Please dispose of packing materials properly.
- During installation, the power cord must not be damaged, bent or flattened.
- Do not tamper with controls.
- The appliance is to be connected to the water mains using new hose sets, and the old hose-sets should not be reused.
- Make sure that the carpet does not obstruct the openings at the bottom base.
- Use the dishwasher only for its intended function.
- The dishwasher is intended for indoor use only.

- The dishwasher is not designed for commercial use. It is intended for use in domestic households and in similar working and residential environments.



Dispose of the dishwasher packaging material correctly.  
Plastic parts are marked with the standard international abbreviations:  
(e.g. PS for polystyrene, padding material)  
This appliance is identified according to the European guideline



Packaging material could be dangerous for children!

### **WARNING!**

Parmco has a commitment to being environmentally responsible. To avoid potential negative impacts on the environment, please ensure that this appliance is disposed of correctly. This product must not be treated as household waste. Instead it should be handed over to an appropriate collection point for recycling of electrical, electronic and steel components. Disposal should always be carried out in an environmentally appropriate manner.

For more detailed information about treatment, recovery and recycling of this product, please contact your local City Council office.

### **IMPORTANT!**

To get the best performance from your dishwasher, read all operating instructions before using it for the first time.

# PRODUCT DESCRIPTION

## Control Panel

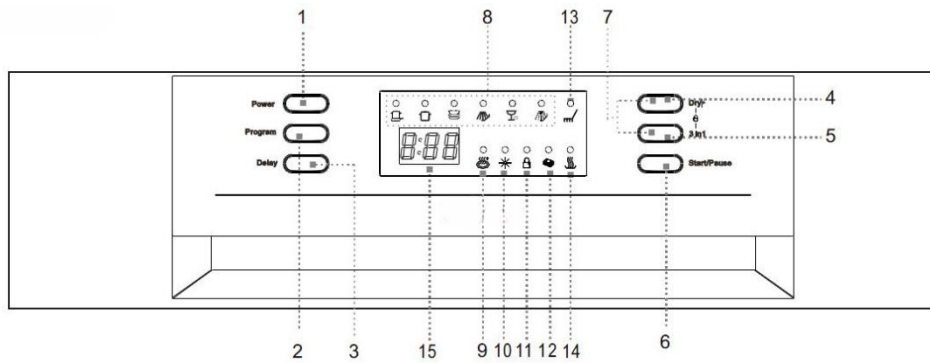

1. Power Button: to turn on/off the power supply.
2. Program button: press the button to scroll through the wash cycles. The corresponding programme light will indicate which wash cycle has been selected.
3. Delay button: the delay start function will allow you to delay the start time of any cycle of up to 24 hours.
4. Dry+ button: press this button to choose or cancel the Dry+ function.
5. 3 in 1 button: press this button to choose or cancel the "3 in 1" function.
6. Start/pause button: the appliance will start or pause the selected wash cycle.
7. Child lock button: press the two buttons (Dry+ and 3 in 1) for 3 seconds, the appliance will be locked and all buttons cannot be used until unlocked. To unlock hold down the same buttons.
8. Program indicator light: When you select a washing programme, the corresponding light will display
9. Dry+ indicator: The indicator will light up when the Dry+ button is selected. An increased temperature will improve the drying process during the final rinse stage. The function can be performed when you choose Intensive, Heavy or Normal wash cycle.
10. Rinse aid refill indicator: This indicator lights up when dispenser needs to be refilled.
11. Child lock indicator: The indicator light will flash 6 times and then remain on when you press the child lock buttons for 3 seconds.
12. 3 in 1 indicator: The indicator lights up when the additional function has been selected
13. Washing light: To come on when the dishwasher is washing
14. Drying light: To come on when the dishwasher is drying
15. Display: To display delay time or error codes or the estimated time left for programme to run.

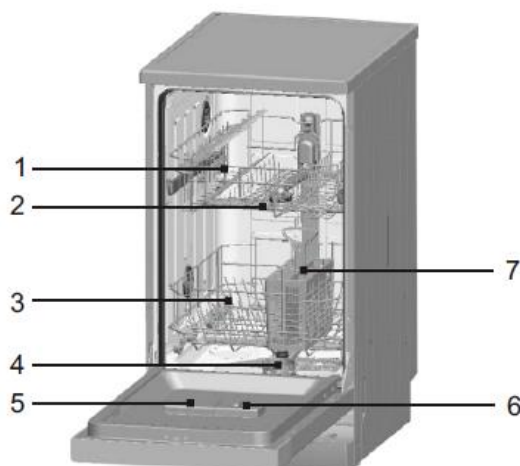

## Front View

- 1 Upper Basket
- 2 Spray Arms
- 3 Lower Basket
- 4 Filters
- 5 Detergent Dispenser
- 6 Rinse Aid Dispenser
- 7 Cutlery basket



# USE AND CARE

## Before using your dishwasher for the first time

- A. Fill the rinse aid dispenser
- B. Fill the detergent dispenser

### A. Fill the Rinse Aid Dispenser Function of Rinse Aid

The rinse aid is released during the final rinse to prevent water from forming droplets on your dishes that can leave spots and streaks. It also improves drying by allowing water to drip off the dishes.

#### Attention!

Only use solutions specified as rinse aid for dishwasher. Never fill the rinse aid dispenser with any other substances (e.g. dishwasher cleaning agent, liquid detergent). This will damage the appliance.

Your dishwashers are designed to use liquid rinse aids. The rinse aid dispenser is located inside the door next to the detergent dispenser.

### When to Refill the Rinse Aid Dispenser

You can judge the amount of rinse aid by the colour of the optical level indicator "D" located next to the cap. When the rinse aid container is full, the whole indicator will be dark. As the rinse aid diminishes, the size of the dark dot decreases. You should never let the rinse aid get below 1 / 4 full. As the rinse aid diminishes, the size of the black dot on the rinse aid level indicator changes, as illustrated (from full -> empty)

- Full
- 3 / 4 full
- 1 / 2 full
- 1 / 4 full - Should refill to eliminate spotting
- Empty

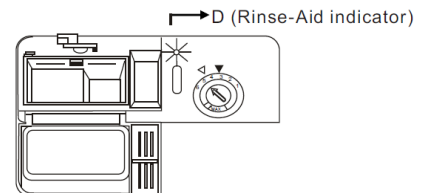

### Rinse Aid Dispenser

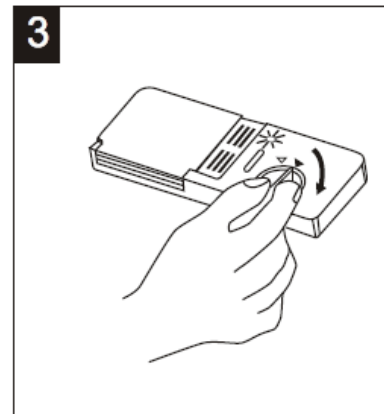
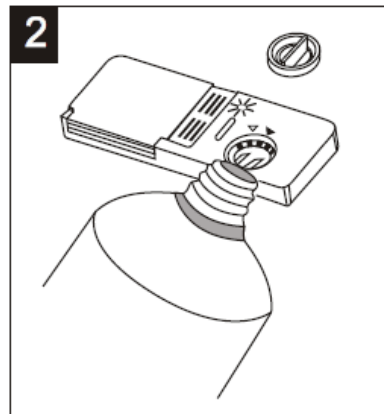
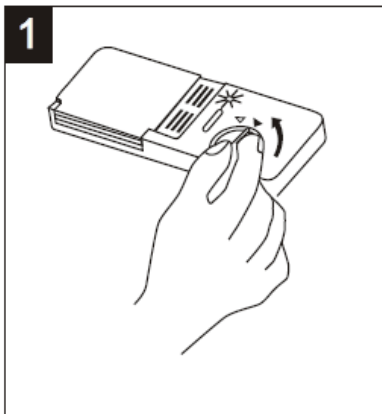

1. To open the dispenser, turn the cap to the "open" (left) arrow and lift it out.
2. Pour the rinse aid into the dispenser until the level indicator turns completely black. Be careful not to overfill this could cause over sudsing. The volume of the rinse aid container is about 140ml.
3. Replace the cap by inserting it aligned with "open" arrow and turning it to the "closed" (right) arrow. Wipe away any spills with a damp cloth.

### Guidance

#### Attention!

Clean up any rinse aid split during filling with an absorbent cloth to avoid excess foaming during the next wash.

### Adjusting Rinse Aid Dispenser

The rinse aid dispenser has four or six settings. Always start with the dispenser set on "4" if spots and poor drying are problems, increase the amount of rinse aid dispensed by removing the dispenser lid and rotating the dial to "5".

If the dishes still are not drying properly or are spotted, adjust the dial to the next higher number until your dishes are spot-free. The dose is factory set in position 5.

**NOTE:** Increase the dose if there are drops of water or lime spots on the dishes after washing.

Reduce it if there are sticky whitish streaks on the dishes or a bluish film on glassware or knife blades.

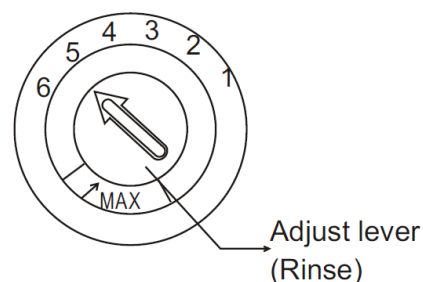

### B. Function of Detergent

Detergents with chemical ingredients are necessary to remove dirt, crush dirt and transport it out of the dishwasher. Most commercial quality detergents are suitable for this purpose.

#### Concentrated Detergent

Based on their chemical composition, detergents can be split in two basic types:

- conventional, alkaline detergents with caustic components
- low alkaline concentrated detergents with natural enzymes.

Use of the "normal" washing programme in conjunction with concentrated detergents reduces pollution and is good for your dishes; these washing programmes are specially matched to the dirt dissolving properties of the enzymes of the concentrated detergent. For this reason "normal" washing programme in which concentrated detergents are used can achieve the same results that can otherwise only be achieved using "intensive" programme.

#### Detergent Tablets

Detergent tablets of different brands dissolve at different speeds. For this reason some detergent cannot dissolve and develop their full cleaning power during short programmes.

Therefore please use long programmes when using detergent tablets, to ensure the complete removal of detergent residues.

## Detergent Dispenser

The dispenser must be refilled before the start of each washing cycle following the instructions provided in the Wash Cycle Table. Your dishwasher uses less detergent and rinse aid than conventional dishwashers. Generally, only one tablespoon of detergent is needed for a normal wash load. Also, more heavily soiled items need more detergent.

**Always add the detergent just before starting dishwasher, otherwise it could get damp and will not dissolve properly.**

## Amount of Detergent

### NOTE:

1. If the lid is closed: press release button. The lid springs open.
2. Always add the detergent just before starting each wash cycle. Only use branded detergent aid for dishwasher.

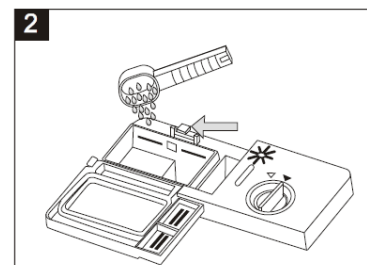
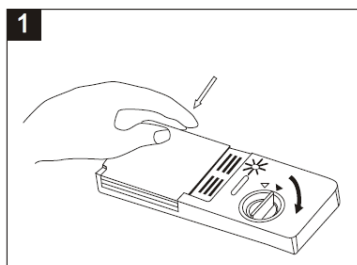

### WARNING!

Dishwasher detergent is corrosive! Take care to keep it out of reach of children

Use only detergent specifically made for use in dishwashers. Keep your detergent fresh and dry.

Don't put powder detergent into the dispenser until you're ready to wash dishes.

## Fill the detergent dispenser

Fill the detergent dispenser with detergent.

The marking indicates the dosing levels, as illustrated on the right:

1. The main wash cycle detergent location, MIN means approximately 20g of detergent.
2. The pre-wash cycle detergent location, approximately 5g of detergent.

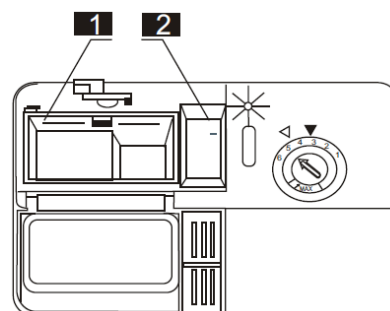

Please observe the manufacturer's dosing and storage recommendations as stated on the detergent packaging.

Close the lid and press until it locks into place.

If the dishes are heavily soiled, place an additional detergent dose in the pre-wash detergent chamber. This detergent will take effect during the pre-wash phase.

**NOTE:** You can find information about the amount of detergent for the single programme on the last page.

## Use of "3 in 1" Detergent Tablets

### General Advice

1. Before using these products you should first check that the water hardness is compatible with the use of these products as per the detergent manufacturer's instructions (on the product packaging).
2. These products should be strictly used according to the detergent manufacturer's instructions.
3. If you encounter problems when using "3 in 1" products for the first time then please contact the detergent manufacturers care line (the telephone number is given on the product packaging).

These products are detergents with integrated and combined detergent/rinse aid functions.

4. Detergent tablets of different brands dissolve at different speeds. For this reason some detergent tablets cannot dissolve and develop their full cleaning power during short wash programs. We recommend selecting long wash programs when using tablets, to ensure optimum efficiency and complete removal of detergent residues.

### To select "3 in 1" function:

1. Close the door and select the 3 in 1 washing cycle by pressing the option button "3 in 1" until the "3 in 1" indicator lights
2. The 3 in 1 washing cycle will be available after pressing the start/pause button and the "3 in 1" indicator lights.

### To cancel "3 in 1" function:

Follow the 'Cancelling a programme in progress' instructions.

If you decide to switch to the use of a standard detergent system we advise that you:

1. Refill the rinse aid compartments.
2. Switch the rinse aid setting to the highest possible position and run for three normal cycles without load.
3. Readjust the rinse aid setting again according to the conditions for your region

**NOTE:** please place 3 in 1 tablet in the cutlery basket.

## Loading the dishwasher baskets

For best performance of the dishwasher, follow these loading guidelines. Features and appearance of baskets and cutlery tray may vary from your model.

### Attention

#### Before or after Loading the Dishwasher Baskets

1. Scrape off any large amounts of leftover food. It is not necessary to rinse the dishes under running water. Place objects in the dishwasher in the following way:
  - A. Items such as cups, glasses, pots/pans, etc. are stood upside down.
  - B. Curve items, or those with recesses, should be at a slant so that water can run off.
  - C. Items are stacked securely and cannot tip over.
  - D. Items do not prevent the spray arms from rotating while washing takes place.
2. Very small items should not be washed in the dishwasher as they could easily fall out of the baskets.
3. The upper and lower baskets cannot be pulled out at the same time when loading the dishwasher or it may lead to tipping

### Removing the Dishes

To prevent water dripping from the upper basket into the lower basket, we recommend that you empty the lower basket first and then the upper basket.

### Loading the Upper Basket

The upper basket is designed to hold more delicate and lighter dishware such as glasses, coffee and tea cup and saucers, as well as plates, small bowls and shallow pans (as long as they are not too dirty). Position the dishes and cookware so that they do not get moved by the spray of water.

Upper basket	
Type	Item
A	Cup
B	Glass
C	Saucer

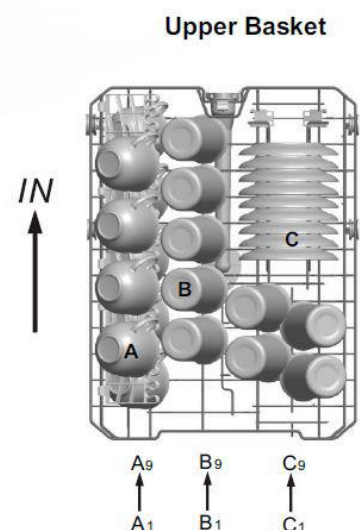

### Adjusting the Upper Basket

If required, the height of the upper basket can be adjusted in order to create more space for large utensils either in the upper basket or lower basket. The upper basket can be adjusted for height by putting wheels of different height into the rails. Long items, serving cutlery, salad servers or knives should be placed on the shelf so that they do not obstruct the rotation of the spray arms. The shelf can be folded back or removed when not required for use.

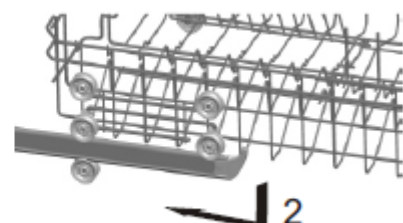
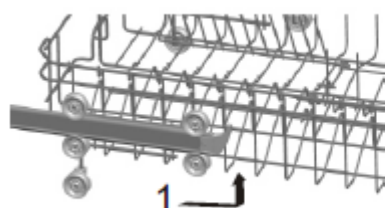

## Loading the Lower Basket

We recommend that you place large items which are most difficult to clean in to the lower basket: pots, pans, lids, serving dishes and bowls, as shown in the figure below.

It is preferable to place serving dishes and lids on the side of the baskets in order to avoid blocking the rotation of the top spray arm.

Pots, serving bowls, etc. must always be placed top down.

Deep pots should be slanted to allow water to flow out.

The bottom basket features 9 rows that can be folded down so that larger pots and pans can be loaded.

### Lower Basket

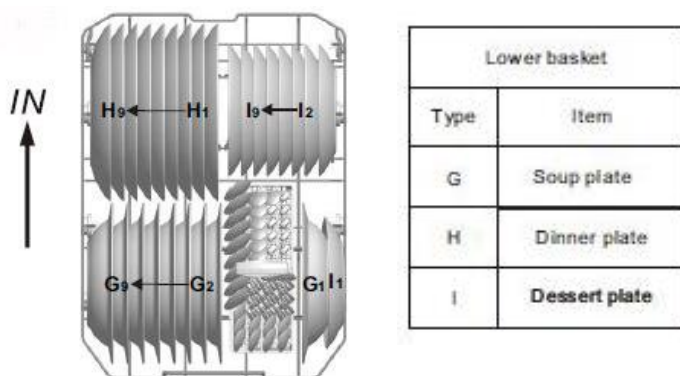

### \*Upper and Lower basket folding racks

Folding racks consisting of two parts that are located on the upper / lower basket of your machine are designed in order to let you place large items easily such as pots, pans, etc. If requested, each part can be folded separately, or all of them can be folded and a larger area can be obtained.

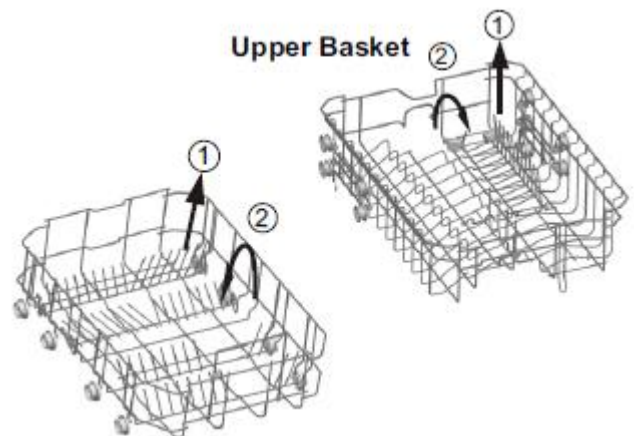

### Cutlery tray

Arrange the cutlery in the tray as shown. Cutlery should be placed to ensure that water runs off freely.

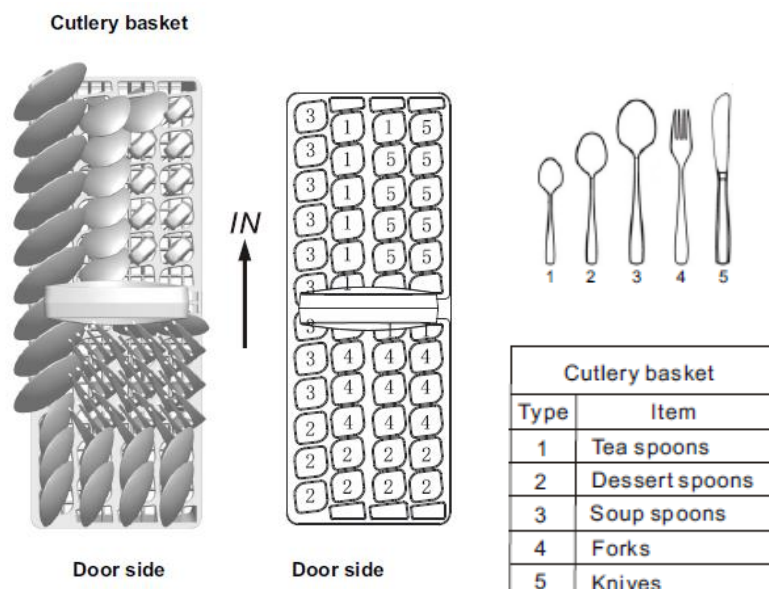

The following cutlery and dishes are not suitable to be washed in a dishwasher:

- Cutlery with wooden, horn china or mother-of-pearl handles
- Plastic items that are not heat resistant
- Older cutlery with glued parts that is not temperature resistant
- Bonded cutlery items or dishes
- Pewter or copper items
- Lead crystal glass
- Steel items subject to rusting
- Wooden items
- Items made from synthetic fibre



**WARNING!**

Do not let any item extend through bottom

**Are of limited suitability**

Some types of glasses can become dull after a large number of washes  
Silver and aluminium parts have a tendency to discolour during washing  
Glazed patterns may fade if machine washed frequently

**NOTE:** Do not put in items that are dirty of cigarette ash, candle wax, lacquer or paint. If you buy new dishes please make sure that they are suitable for dishwashers.

**NOTE:** Please do not overload your dishwasher. There is only space for 9 standard dishes. Do not use dishes that are not suitable for dishwashers. This is important for good results and for reasonable energy consumption.

**Loading Cutlery and Dishes**

Before loading the dishes, you should:

- Remove large left-overs
- Soften remnants of burnt food in pans

**When Loading the Dishes and Cutlery, please Note:**

Dishes and cutlery must not impede the rotation of the spray arms or opening of detergent dispenser.

Load hollow items such as cups, glasses, pans etc. with the opening downwards so that water cannot collect in the container or a deep base.

Dishes and items of cutlery must not lie inside one another, or cover each other

- To avoid damage to glasses, they must not touch
- Load large items which are most difficult to clean into the lower basket
- The upper basket is designed to hold more delicate and lighter dishware such as glasses, coffee and tea cups

**Attention!**

Long bladed knives stored in an upright position are a potential hazard!

Long and/or sharp items of cutlery such as carving knives must be positioned horizontally in the upper basket

**Damage to Glassware and other Dishes****Possible causes:**

- Type of glass or manufacturing process. Chemical composition of detergent.
- Water temperature and duration of dishwasher programme.

**Suggested remedy:**







- Use glassware or porcelain dishes that have been marked dishwasher-proof by the manufacturer.
- Use a mild detergent that is described as "kind on dishes". If necessary, seek further information from detergent manufacturers.
- Select a programme with a low temperature.
- To prevent damage, take glass and cutlery out of the dishwasher as soon as possible after the programme has ended.

**At the End of the Wash**

When the working cycle has finished, the buzzer will ring for 6 times, then stop. Turn off the appliance using the "Power " button, shut off the water supply and open the door of the dishwasher. Wait a few minutes before unloading the dishwasher to avoid handling the dishes and utensils while they are still hot and more susceptible to breakage. They will also dry better.



# WASHING CYCLES

Program	Cycle Selection Information	Description of Cycle	Detergent Pre/main	Running Time (min)	Energy (kWh)	Water (L)
 Intensive	For the heaviest soiled loads, such as pots, pans, casserole dishes and dishes that have been sitting with dried food on them for a while.	Pre-wash(40°C) Main wash(55°C) Rinse1 Rinse2 Hot rinse(65°C) Drying	4/22g (Or 3 in 1)	137	1.10	15.0
 Heavy	For heavy soiled loads, such as pots, plates, glasses and lightly soiled pans. standard daily cycle.	Main wash(60°C) Rinse 1 Rinse 2 Hot rinse(65°C) Drying	4/22g (Or 3 in 1)	122	1.00	11.5
 Normal (AS/NZS 2007.1)	For normally soiled loads, such as pots, plates, glasses and lightly soiled pans. standard daily cycle.	Main wash(44°C) Rinse Hot rinse(46°C) Drying	4/22g (Or 3 in 1)	110	0.56	9.4
 Rinse	For dishes that need to be rinsed and dried only	Pre-wash Hot rinse(70°C) Drying	4/22g	60	0.69	6.0
 Rapid	A shorter wash for lightly soiled loads that do not need drying.	Main wash(40°C) Hot rinse(50°C)	15g	43	0.48	6.0
 Soak	To rinse dishes that you plan to wash later that day	Pre-wash	/	8	0.01	3.3



NOTE: We recommend you open the door slightly 50mm to assist in drying of the dishes after every wash.

## Turning on the appliance

### Starting a wash cycle

1. Draw out the lower and upper basket, load the dishes and push them back. It is recommended to load the lower basket first, then the upper one (see the section entitled "Loading the Dishwasher").
2. Pour in detergent
3. Insert the plug into the socket. The power supply is 220-240V AC 50 Hz, the specification of the socket is 12 A 250 VAC.50 Hz.

Make sure that the water supply is turned on to full pressure. Close the door with a little force to ensure the door is properly closed.

Press the "Power" button, and Press the "program" button to select a desired "Wash cycle". (See the section entitled "Wash Cycle Table".)

**NOTE:** A click could be heard when the door is closed perfectly.

When the washing is over, you can turn off the dishwasher by pressing "Power" button.

## Change the programme

Premise: A cycle that is underway can only be modified if it has only been running for a short time.

Otherwise, the detergent may have already been released, and the appliance may have already drained the wash water. If this is the case, the detergent dispenser must be refilled (see the section entitled "Fill in the Detergent").

Open the door, Press current programme button more than three seconds to cancel the programme, then you can change the programme to the desired cycle setting (see the section entitled "Starting a wash cycle"). Then, close the door.

NOTE: If you open the door when washing, the machine pauses and a warning alarm rings, the display shows E1. When you close the door, the machine will restart after 10 seconds.

The 6 programme lights show the state of the dishwasher:

- a) All program lights off --> stand by
- b) One of the program lights on --> cycle running
- c) One of the program lights blinking --> pause

Note: If all the lights begin to flicker, that indicates the machine is out of order, please turn off the main power and water supply before calling for a service agent.

## Forgot to add a dish

**A forgotten dish can be added any time before the detergent dispenser opens.**

- 1 Open the door a little to stop the washing.
- 2 After the spray arms stop working, you can open the door completely.
- 3 Add dishes.
- 4 Close the door, the dishwasher will work after 10 seconds.



### **WARNING!**

It is dangerous to open the door when washing, because hot water may burn you.

Switch Off the Dishwasher

The digital display appears "---" and the buzzer rings 6 times, only in this case the programme has ended.

1. Switch off the dishwasher by pressing the "Power " button.

Open the door carefully. Hot steam may escape when the door is opened!

Hot dishes are sensitive to knocks. The dishes should therefore be allowed to cool down around 15 minutes before removing from the appliance.

Open the dishwasher's door, leave it ajar and wait a few minutes before removing the dishes. In this way they will be cooler and the drying will be improved.

## Unloading the dishwasher

It is normal that the dishwasher is wet inside.

Empty the lower basket first and then the upper one. This will avoid water dripping from the upper basket onto the dishes in the lower one.

# CLEANING AND MAINTENANCE

Filtering system: The filter is used to collect large leftovers and other sundries getting inside the pump. The residue can sometimes obstruct the filter.

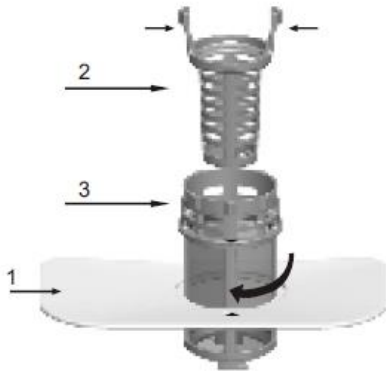

The filter system consists of a coarse filter, a flat (Main filter) and a micro filter (fine filter).

### 1 Flat filter

Food and debris will be trapped by a special jet on the lower spray arm.

### 2 Coarse filter

Big debris, such as bone and glass that could clog the drain will be trapped in the coarse filter. To remove an item caught in this filter, gently squeeze the tabs on the top of this filter and lift it out.

### 3 Micro filter

This filter holds soil and food residue in the sump area and prevents it from being redeposited on the dishes during a cycle.

- Inspect the filters for obstructions every time the dishwasher has been used.
- By unscrewing the coarse filter, you can remove the filter system. Remove any food remnants and clean the filters under running water.

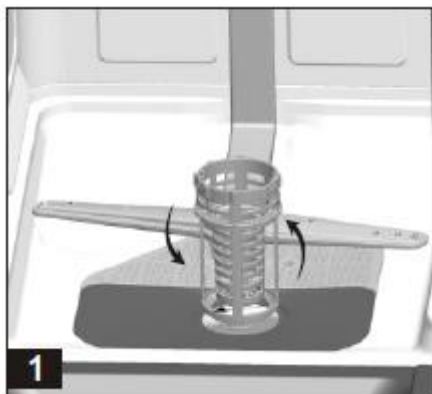

Step 1: rotate the coarse filter anti clockwise and then lift it up;  
Step 2: lift the flat

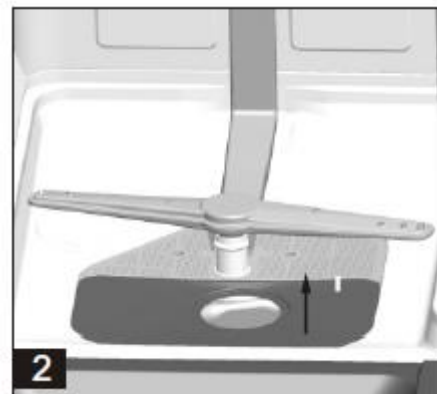

filter up

**NOTE:** Follow step 1 to step 2 to remove the filter system. Follow step 2 to step 1 to reinstall the filter system.

### Filter assembly

For best performance and results, the filter assembly must be cleaned regularly. The filter efficiently removes food particles from the wash water, allowing it to be recirculated during the cycle. For this reason, it is a good idea to remove the larger food particles trapped in the filter after each wash cycle by rinsing all filters under running water. The entire filter assembly should be cleaned once a week. To clean the coarse filter and the micro filter, use a cleaning brush. Then, reassemble the filter parts as shown in the figures above and

reinsert the entire assembly in the dishwasher, positioning in its seat, pressing downward and twisting into place. The dishwasher must never be used without the filters. Incorrect replacement of the filter may reduce the performance level of the appliance and damage dishes and utensils.



### **WARNING!**

Never run the dishwasher without the filters in place. When cleaning the filters, don't squash them otherwise, the filters could be bent and the performance of dishwasher could be reduced.

### **Cleaning the Spray Arms**

It is necessary to clean the spray arms regularly for hard water chemicals will clog the spray arm jets and bearings.

To remove the spray arms, screw off the nut clockwise to take out the washer on top of the spray arm and remove the arm. Wash the arms in warm soapy water and use a soft brush to clean the jets. Replace them after rinsing thoroughly.

### **Caring for the Dishwasher**

To clean the control panel, use a lightly dampened cloth then dry thoroughly.

To clean the exterior, use a good appliance polish wax.

Never use sharp objects, scouring pads or harsh cleaners on any part of the dishwasher.

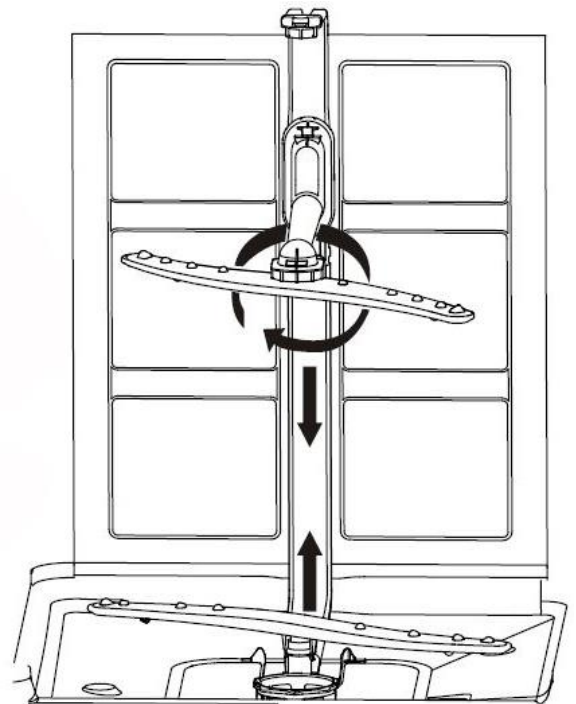

### **Protect Against Freezing**

If your dishwasher is left in an unheated place during the winter, ask a service agent to:

1. Cut off electrical power to the dishwasher.
2. Turn off the water supply and disconnect the water inlet pipe from the water valve.
3. Drain water from the inlet pipe and water valve. (Use a pan to catch the water)
4. Reconnect the water inlet pipe to the water valve.
5. Remove the filter in the tub and the bottom and use a sponge to soak up water in sump.

### **Cleaning the Door**

To clean the edge around the door, you should use only a soft warm, damp rag. To prevent penetration of water into the door lock and electrical components, do not use a spray cleaner of any kind.



### **WARNING!**



Never use a spray cleaner to clean the door panel for it could damage the door lock and electrical components. Do not use abrasive agents or paper towel because of the risk of scratching or leaving spots on the stainless steel surface.

### **How to Keep Your Dishwasher in Shape**



- **After Every Wash**  
After every wash leave the door slightly ajar so that moisture and odours are not trapped inside.
- **Remove the Plug**  
Before cleaning or performing maintenance, always remove the plug from the power socket.
- **No Solvents or Abrasive Cleaning**  
To clean the exterior and rubber parts of the dishwasher use a soft cloth and warm soapy water. Do not use solvents or abrasive cleaning products. To remove spots or stains from the surface of the interior, use a cloth dampened with water and a little white vinegar, or appropriate cleaning product.
- **When You Go on holiday**  
When you go on holiday, it is recommended that you run a wash cycle with the dishwasher empty and then remove the plug from the socket, turn off the water supply and leave the door of the appliance slightly ajar. This will help the seals last longer and prevent odours from forming in the appliance.
- **Moving the Appliance**  
If the appliance must be moved, try to keep it in the vertical position. If absolutely necessary, it can be positioned on its back.
- **Seals**  
One of the factors that cause odours to form in the dishwasher is food that remains trapped in the seals. Periodic cleaning with a damp sponge will prevent this.

### **Attention:**

The installation of the pipes and electrical equipment's should be done by professionals.

 <b>Warning</b>	
	<b>Electrical Shock Hazard!</b> Disconnect electrical power before installing dishwasher. Failure to do so can result in death or electrical shock.



# INSTALLATION

-  Keep this instruction manual in a safe place for future reference. If the appliance is sold, given away or moved, please ensure the manual is kept with the appliance, so that the new owner may benefit from the information contained within it.
-  Please read this instruction manual carefully: it contains important information regarding the safe installation, use and maintenance of the appliance.
-  If the appliance must be moved at any time, keep it in an upright position; if absolutely necessary, it may be tilted onto its back.

## Positioning and levelling

1. Remove the appliance from all packaging and check that it has not been damaged during transportation. If it has been damaged, contact the retailer and do not proceed any further with the installation process.
2. Check the dishwasher by placing it in the space so that its sides or back panel are in contact with the adjacent cabinets or wall. This appliance can also be recessed under a single work top.
3. Position the dishwasher on a level and sturdy floor. If the floor is uneven, the front feet of the appliance may be adjusted until it reaches a horizontal position (the angle of incline must not exceed 2 degrees). If the appliance is levelled correctly, it will be more stable and much less likely to move or cause vibrations and noise while operating.

## Connection to electrical and water supplies

-  Connection to electrical and water supplies should only be performed by a qualified technician.
-  The dishwasher should not stand on top of the water hoses or the electricity supply cable
-  The appliance must be connected to the water supply network using new hose supplied with the unit. Do not use old hoses.

## Connecting the water inlet hose (Optional)

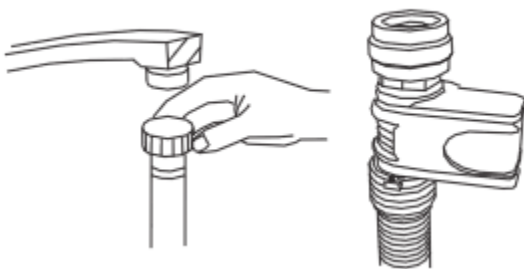

Connect the cold water supply hose to a threaded 3/4(inch) connector and make sure that it is fastened tightly in place.

If the water pipes are new or have not been used for an extended period of time, let the water run to make sure that the water is clear and free of impurities. If this precaution is not taken, there is a risk that the water inlet can get blocked and the appliance could be damaged.

## Connecting the water outlet hose

Fit the drain hose of your machine to the drainage pipe without bending. Take extra care to ensure the drainage pipe is not kinked during installation.

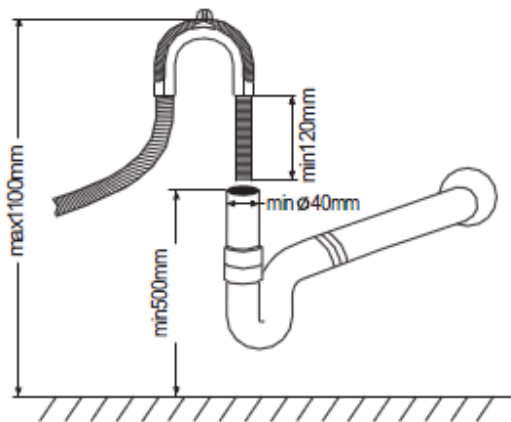

If the length of the hose is not sufficient, contact the authorized service supplier for an extension made from the same material as the original. Remember that the length of the hose should not exceed 4 meters even when with an extension.

If the drainage hose is longer than 4 meters, the dishes will not be cleaned properly. Secure your hose firmly to the drainage pipe to avoid it coming off during the washing process.

## Electrical connection

Before inserting the plug into the electrical socket, make sure that:

- the socket is earthed and complies with current regulations;
- the socket can withstand the maximum load of the appliance, which is indicated on the data label located on the inside of the door (see description of the appliance);
- the power supply voltage is within the values indicated on the data label found inside the door;
- the socket is compatible with the plug of the appliance. If this is not the case, ask an authorised technician to replace the plug; do not use extension cables or multiple sockets.



Once the appliance has been installed, the power supply cable and the electrical socket should be easily accessible.



The cable should not be bent or compressed.



If the power supply cable is damaged, it must be replaced by the manufacturer or its qualified technician in order to prevent all potential hazards.



The company shall not be held responsible for any incidents that occur if these regulations are not observed.

## Advice regarding the first wash cycle

After the appliance has been installed, immediately before running the first wash cycle, completely fill the dispenser with rinse aid (see rinse aid).

## **Positioning the Appliance**

Position the appliance in the desired location. The back should rest against the wall behind it, and the sides, along the adjacent cabinets or wall. The dishwasher is equipped with water supply and drain hoses that can be positioned to the right or the left to facilitate proper installation.

## **Levelling the Appliance**

Once the appliance is positioned, adjust the feet (screwing them in or out) to adjust the height of the dishwasher, making it level. In any case, the appliance should not be inclined more than 2°.

**NOTE:** The maximum adjustment height of the feet is 20 mm.

## **How to Drain Excess Water from Hoses**

If the sink is 1000mm higher from the floor, the excess water in hoses cannot be drained directly into the sink. It will be necessary to drain excess water from hoses into a bowl or a suitable container that is held outside and lower than the sink.

## **Water Outlet**

Connect the water drain hose. The drain hose must be correctly fitted to avoid water leaks. Ensure that the water inlet hose is not kinked or squashed.

## **Extension Hose**

If you need a drain hose extension, use a similar drain hose. It must be no longer than 4 metres; otherwise the cleaning efficiency of the dishwasher could be reduced.

## **Syphon Connection**

The waste connection must be at a height of between 50cm (minimum) and 100cm (maximum) from the bottom of the dishwasher. The water drain hose should be fixed by a hose clip.

## **Start of Dishwasher**

The following should be checked before starting the dishwasher:

- 1) Whether the dishwasher is level and fixed.
- 2) Whether the inlet valve is opened.
- 3) Whether there is leakage at the connections of the hoses.
- 4) Whether the wires are tightly connected.
- 5) Whether the power is switched on.
- 6) Whether the inlet and drain hoses are knotted.
- 7) All packing materials and printed materials should be removed from the dishwasher.

After installation, please place manual and other printed materials for the appliance in a safe and accessible place.



# TROUBLESHOOTING TIPS

## ERROR CODES

When some malfunctions occurs, the appliance will display error codes to warn you.

Codes	Meanings	Possible Causes
E1	Door open	The door is opened when the dishwasher is operating
E2	Water inlet	Water inlet malfunction
E3	Water drainage	Water drainage malfunction
E4	Temperature sensor	Temperature sensor malfunction
E5	Overflow/leakage	Overflow occurs/Water leakage occurs
E6	Water leakage	Water leakage occurs
E7	Heating element	Abnormal heating



### WARNING

If overflow occurs, turn off the main water supply before calling for a service agent. If there is water in the base of the appliance because of an overfill or small leak, the water should be removed before restarting the dishwasher.

## Before Calling for Service

Problem	Possible Causes	What To Do
Dishwasher doesn't run	Fuse blown, or the circuit breaker tripped	Replace fuse or reset circuit breaker. Remove any other appliances sharing the same circuit with the dishwasher.
	Power supply is not turned on	Make sure the power cord is properly plugged into the wall socket.
	Water pressure is low	Check that the water supply is connected properly and the water is turned on. Check door is closed.
Drain pump doesn't stop	Overflow	The system is designed to detect an overflow. When it does, it shuts off the circulation pump and turns on the drain pump.
Noise	Some audible sounds are normal	Sound from detergent cup opening.
	Utensils are not secure in the baskets or something small has dropped into the basket	Ensure everything is secured in the dishwasher.
	Motor hums	Dishwasher has not been used regularly. If you do not use it often, remember to set it to fill and pump out every week, which will help keep the seal moist.
Suds in the tub	Improper detergent	Only use dishwasher detergent to avoid suds. If this occurs, open the dishwasher and let suds evaporate. Add 4 litres of cold water to the tub. Close and latch the door, then start the "soak" wash cycle to drain out the water. Repeat if necessary.
	Spilled rinse agent	Always wipe up rinse agent spills immediately.
Stained tub interior	Detergent with colorant was used	Make sure that the detergent is the one without colorant.
Dishes and flatware not clean	Improper program Improper basket loading	Select another programme. Make sure that the action of the detergent dispenser and spray arms are not blocked by large dishware.
Spots and filming on glasses and flatware	<ol style="list-style-type: none"> <li>1 Extremely hard water</li> <li>2 Low inlet temperature</li> <li>3 Overloading the dishwasher</li> <li>4 Improper loading</li> <li>5 Old or damp powder detergent</li> <li>6 Empty rinse aid dispenser</li> <li>7 Incorrect dosage of detergent</li> </ol>	<p>To remove spots from glassware:</p> <ol style="list-style-type: none"> <li>1 Take out all metal utensils out of the dishwasher.</li> <li>2 Do not add detergent.</li> <li>3 Choose the longest cycle.</li> <li>4 Start the dishwasher and allow it to run for about 18 to 22 minutes, then it will be in the main wash.</li> <li>5 Open the door to pour 2 cups of white vinegar into the bottom of the dishwasher.</li> <li>6 Close the door and let the dishwasher complete the cycle. If the vinegar does not work: Repeat as above, except use 1/4 cup (60 ml) of citric acid crystals instead of vinegar.</li> </ol>

Cloudiness on glassware	Combination of soft or hard water and too much detergent	Use less detergent if you have soft water and select a shortest cycle to wash the glassware and to get them clean.
Yellow or brown film on inside surfaces	Tea or coffee stains	Using a solution of 1/2 cup of bleach and 3 cups of warm water to remove the stains by hand. <b>WARNING</b> You have to wait for 20 minutes after a cycle to let the heating elements cool down before cleaning interior; otherwise, burns will happen.
	Iron deposits in water can cause an overall film	You have to call a water softener company for a special filter.
White film on inside surface	Hard water minerals	To clean the interior, use a damp sponge with dishwasher detergent and wear rubber gloves. Never use any other cleaner than dishwasher detergent for the risk of foaming or suds.
The detergent dispenser lid cannot be closed properly	Clogged detergent residue is blocking the catch	Clean the detergent from the catch.
Detergent left in dispenser cups	Dishes block detergent Cups	Re-loading the dishes properly.
Steam	Normal phenomenon	There is some steam coming through the vent by the door latch during drying and water draining.
Black or grey marks on dishes	Aluminium utensils have rubbed against dishes	Use a mild abrasive cleaner to eliminate those marks.
Water standing on the bottom of the tub	This is normal	A small amount of clean water around the outlet on the tub bottom keeps the water seal lubricated.
Dishwasher leaks	Overfill dispenser or rinse aid spills	Be careful not to overfill the rinse aid dispenser. Spilled rinse aid could cause over sudsing and lead to overflowing. Wipe away any spills with a damp cloth.
	Dishwasher isn't level	Make sure the dishwasher is level.

# TECHNICAL INFORMATION

<b>W x D x H</b>	450mm 600mm 845mm
<b>Voltage connected load:</b>	See data label
<b>Water pressure:</b>	0.04--1.0MPa
<b>Power supply:</b>	See data label
<b>Capacity:</b>	9 Place settings
<b>Hot water connection:</b>	Max 60°C