

Installation and Operating Instructions

Model:

OX7-2-6S-5

OX7-2-6S-8

For your convenience, we recommend to attach the serial number label HERE.

As part of Parmco Appliances commitment to improving and updating product ranges, we reserve the right to alter, change and update technical specifications and appearance attributes of all Parmco Appliances products. E&OE.

727626042017





p: 09 573 5678
 f: 09 573 5699
 e: sales@parmco.co.nz
 w: www.parmco.co.nz



Parmco Appliances extended 7 year warranty

The Warranty:

- This appliance is intended for domestic use in the owners' home. Use of the appliance for commercial purposes will limit the warranty period (please see Parmco website for commercial details).
- Subject to the terms and conditions contained within this warranty, if the product is not of Acceptable Quality (as defined in the Consumer Guarantees Act) within 7 years of the date of original purchase, then Parmco Sales undertakes to repair or, at its sole discretion, replace the product.
- The warranty does not cover the costs of transport, mileage or travelling time if the product is located beyond 30km of a recognised Service Agent.
- This warranty is offered as an extra benefit, and does not affect other legal rights, which can not be modified or excluded by agreement.
- This warranty only applies to goods supplied and installed in the North and South Islands of New Zealand.
- The provisions of this warranty are in addition to the rights and remedies available to consumers under the Consumer Guarantees Act 1993.

Product _____ Date of purchase _____
 Serial Number _____
 Dealer / Retailers Name _____

Please retain this Warranty card together with receipt or other proof of purchase date when seeking service during the warranty period

Please contact Parmco at 09 573 5678 if your appliance needs servicing under warranty. Please have your model number and proof of purchase ready. Warranty repairs must be authorized by Parmco.



The Warranty is not valid:

- If the product is not installed and operated in accordance with the operating instructions.
- If the product is not installed to comply with the electrical, gas, plumbing and other Regulations and Codes of Practice in New Zealand.
- If the product is operated on voltages or frequencies outside the normal range for domestic appliances in New Zealand.
- If the product is not used in normal domestic use, or if it is used in a business as defined in the Consumer Guarantees Act.
- If any serial number has been removed or defaced.
- If proof of date of purchase is not supplied, except at the sole discretion of Parmco Sales. Proof of purchase can be for the product itself, or if installed with a kitchen or house then proof of purchase can be from a Parmco reseller of products supplied by Parmco.
- If the products are purchased in a second hand condition from other parties (including but not limited to TradeMe, Sella, etc.)

Liability under this warranty will not be accepted for:

- Wear and tear caused by normal domestic use of the product.
- Damage in transport.
- Damage caused to the product by neglect, abuse, negligence, wilful act or misuse.
- Any costs associated with the repair, replacement, removal or reinstallation of products installed in a damaged condition.
- Any defect caused by accident, misuse, neglect, tampering with or unauthorised modifications of the appliance or any attempt at internal adjustment or repair by any person other than an Authorised Service Agent.
- Service calls that relate principally to the following:
 - Instruction on how to use the product.
 - Repair or replacement of house fuses, electrical wiring, gas fitting or plumbing.
 - Normal or scheduled maintenance including blocked filters or ducting.
 - Consumable items such as light bulbs.
 - Any damage to hobs caused by spills when cooking.
 - Any breakage or damage of glass items.
- Any damage caused by non recommended product used for cleaning, maintaining, lubricating or similar.
- Any aspect relating to the installation of the product, or damage caused during installation including blocked access for repair.
- Any third party (including reseller) or consequential loss or damage (direct or indirect) however arising.



PARMCO

Dear Valued Customer,

Thank you and congratulations on purchasing your new Parmco appliance.

All Parmco products are made to the highest quality and design standards. We are sure you will enjoy your new appliance.

As a note, please read through these instructions carefully. These will assist you in gaining a complete understanding of the functions and features offered by your appliance. Please take special note of all detailed technical information and installation instructions. It is essential that you follow these instructions to ensure the safety and reliability of this appliance.

Furthermore, not using appropriate personnel to install this appliance may affect any future warranty claims lodged, so please check with Parmco Appliances before any installation is carried out.

We hope you enjoy your new appliance. If you would like to find out more about this product or any other products in Parmco's extensive range, visit us online at www.parmco.co.nz.

Regards,
The Parmco Team

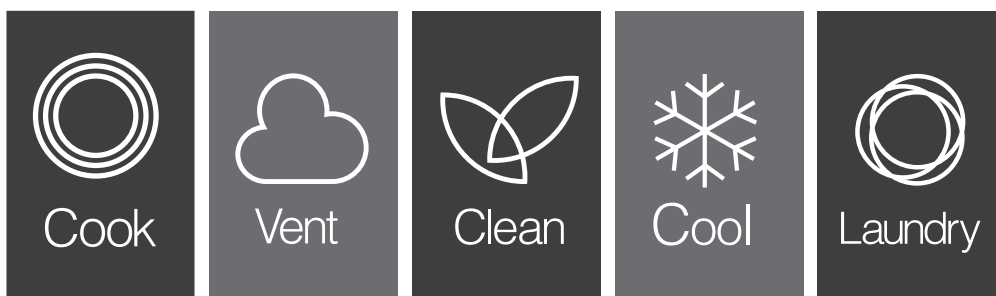

TABLE OF CONTENTS

Safety instructions.....	2
How to save energy.....	3
Disposal of the appliance.....	3
Unpacking.....	3
Description of the appliance.....	4
Installation.....	5
Operation.....	8
Prior first use.....	8
Electronic programmer.....	8
Mechanical timer.....	14
Oven.....	15
Cleaning and maintenance.....	17
Operation in case of emergency.....	20
Baking in the oven.....	21
Technical information.....	24

SAFETY INSTRUCTIONS

The appliance becomes very hot during operation. Take care not to touch the heating elements inside the oven.

WARNING: Accessible parts may become hot during use. To avoid burns, please take care around the appliance and keep young children away.

Keep main leads of adjacent appliances from being caught in the door of the oven to avoid damage.

Never place pans or other items on the open door of the oven.

Do not use the oven in the event of a technical fault. Once a technical fault occurs, disconnect the power and report the fault to the service centre to be repaired.

Never clean the oven with the high-pressure steam cleaning device, as it may damage the electrical components.

Do not use harsh abrasive cleaners or sharp metal scrapers to clean the door glass as they can scratch the surface, which could then result in the glass shattering.

The rules and provisions contained in this instruction manual should be strictly observed. Do not allow anybody who is not familiar with the contents of this instruction manual to operate the oven.

If the supply cord is damaged, it must be replaced by the manufacturer, a service agent or similarly qualified persons in order to avoid a hazard.

The appliance is not intended for use by persons (including children) with reduced physical, sensory or mental capabilities, or lack of experience and knowledge, unless they have been given supervision or instruction concerning the use of the appliance by a person responsible for their safety.

Children should be supervised to ensure that they do not play with the appliance.

This appliance can be used by children aged from 8 years and above and persons with reduced physical, sensory or mental capabilities or lack of experience and knowledge if they have been given supervision or instruction concerning use of the appliance in a safe way and understand the hazards involved. Cleaning and user maintenance should not be undertaken by children without supervision.

WARNING: Ensure that the appliance is switched off before replacing the lamp/light to avoid the possibility of electric shock.

HOW TO SAVE ENERGY



Using energy in a responsible way not only saves money but also helps the environment.

So let's save energy! And this is how you can do it:

Make use of residual heat from the oven. If the cooking time is greater than 40 minutes, switch off the oven 10 minutes before the end time. Important when using the timer, set appropriately shorter cooking times according to the dish being prepared where possible.

Make sure the oven door is closed properly. Cooking residues/spillages left on the door seal can cause the door not to close with a tight seal, which can cause heat to escape from the oven.

Clean up any spillages immediately.

Do not install the oven in the direct vicinity of refrigerators/freezers. Otherwise energy consumption increases unnecessarily.

PACKING



During transportation, protective packaging was used to protect the appliance against any damage. After unpacking, please dispose of all elements of packaging in a way that will not cause harm to the environment.

All materials used for packaging the appliance are environmentally friendly. They are 100% recyclable and are marked with the appropriate symbol.

Caution!

During unpacking, the packaging materials (polythene bags, polystyrene pieces, etc.) should be kept out of reach of children.

DISPOSAL OF THE APPLIANCE



Old appliances should not simply be disposed of with normal household waste, but should be delivered to a collection and recycling centre for electric/ electronic equipment.

A symbol shown on the product, the instruction manual or the packaging shows that it is suitable for recycling.

Some materials used inside the appliance are recyclable. Recycling materials or other parts from used devices will make a significant contribution to the protection of our environment.

Information on appropriate disposal centres for used devices can be provided by your local authority.

DESCRIPTION OF THE APPLIANCE

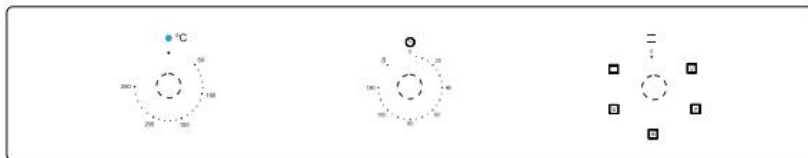
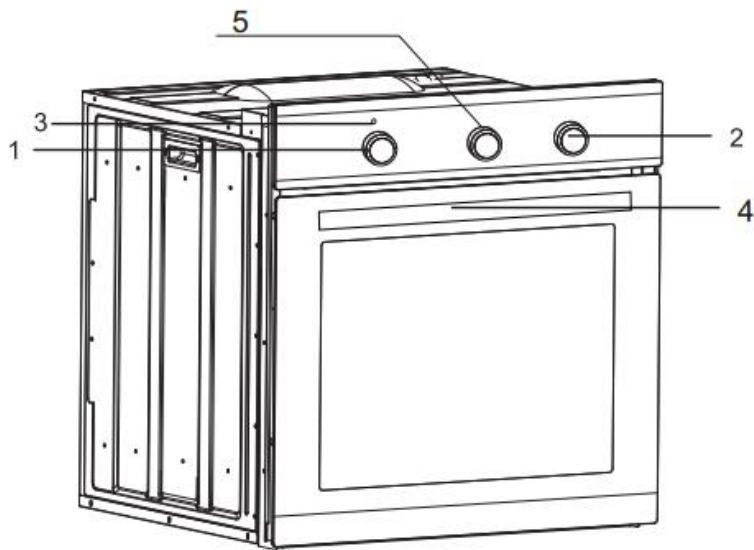

OX7-2-6S-5

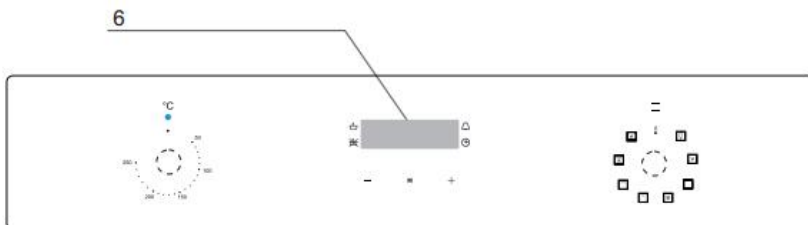

OX7-2-6S-8

1. Temperature control knob
2. Oven function selection knob
3. Oven temperature indicator light
4. Oven door handle
5. Mechanical timer
6. Electronic programmer (8 function oven only)

INSTALLATION

Installing the oven

- The kitchen should be dry and have effective ventilation according to the existing technical provisions
- Main lead behind the oven must be placed in such manner to avoid touching the back panel of the oven because of the heat it develops during operation
- Remove any packaging materials (foils, artificial foam, plastics nails, etc.) from the reach of children, because they represent potential danger. Children may swallow small parts, or suffocate with foils, plastics etc.
- This is a built-in oven, which means that its back wall and one side wall can be placed next to a high piece of furniture or a wall. Coating or veneer used on fitted cabinetry must be heat resistant in accordance with the relevant local standards. This prevents surface deformation for cabinetry. If you are unsure of your cabinetry's heat resistance, you should leave approximately 2cm of free space around the oven. The wall behind the oven should be resistant to high temperatures. During operation, the back of the oven can heat up to around 500°C above the ambient temperature.
- Make an opening with the dimensions given in the diagram for the oven to be fitted
- The appliance must be earthed.
- Insert the oven completely into the opening without allowing the four screws in the places shown in the diagram to fall out.

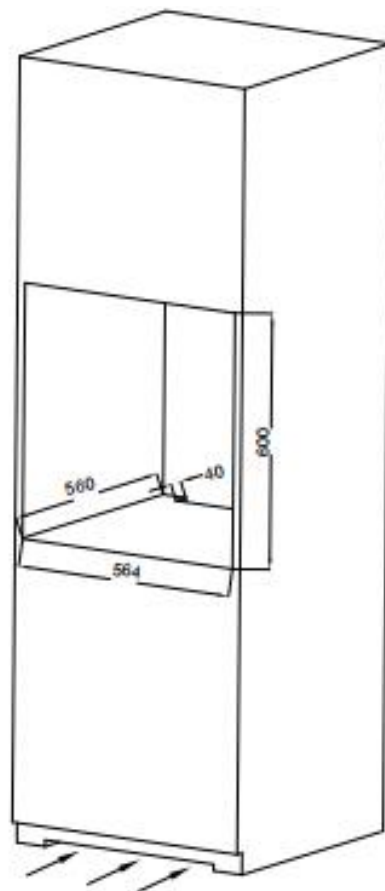
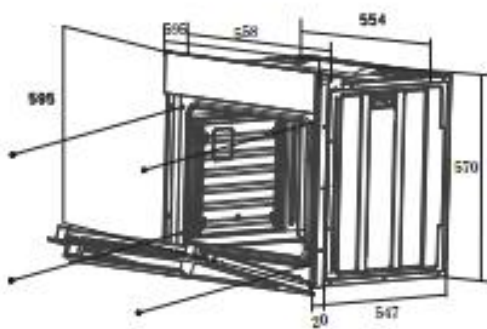
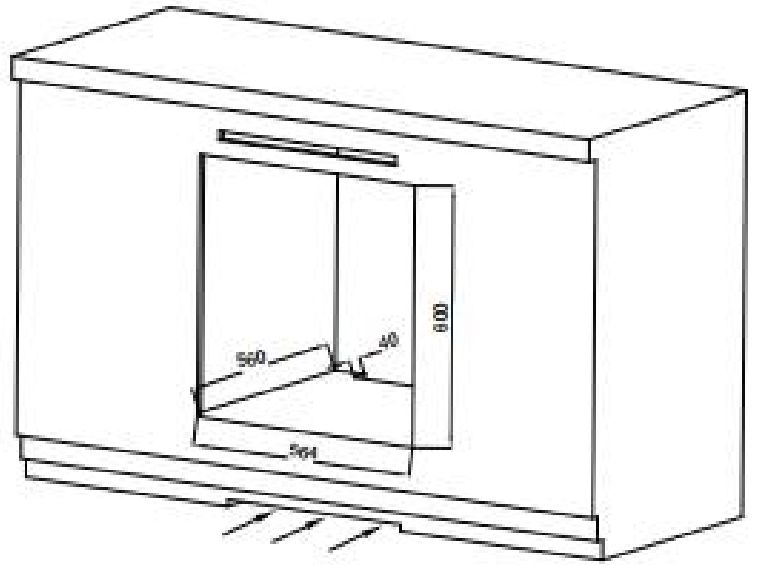
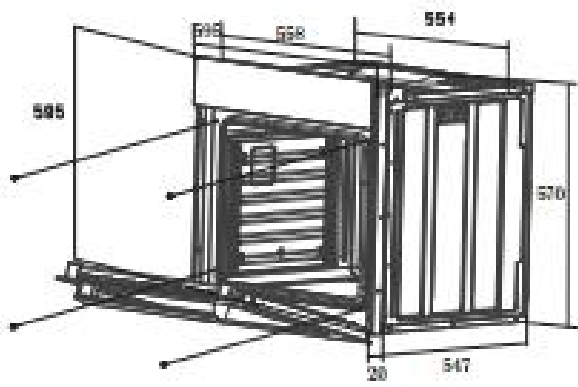

Electrical connection

Warning!

All electrical work must be carried out by a qualified and authorized electrician.

- Before attempting the connection, check whether the voltage indicated on the rating plate corresponds to the actual mains voltage.
- Mains lead should be minimum 1.5m long.
- Earthing wire should be installed in such manner to be the last one pulled out in case the safety relief device of the mains lead should fail.
- Mains lead behind the oven must be placed in such manner to avoid touching the back panel of the oven because of the heat it develops during operation.
- The cable of correct size rating must be used. Cable type H05VV-F 3×1.5m m² or equivalent can be used. The grounding wire should be longer than the other wires.

Connection

- Using the screwdriver open the connector cover at the rear of the appliance. Release two locks located at either side of the connector bottom.
- Mains lead must be led through the relief safety device, protecting the mains lead cable from disconnection.
- Tighten the relief device securely and close the connector cover.

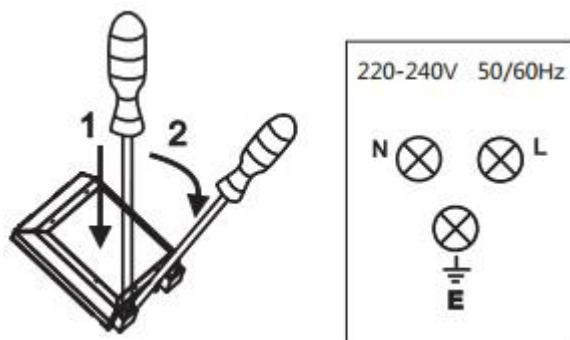

Colour code

L=exterior live wires, usually coloured black, brown.

N=neutral

The colour is usually blue.

Beware of the correct N-connection!

 **E=earthing wire, the colour is green/yellow.**

OPERATION

Prior first use

- Remove packaging, clean the interior of the oven with soft damp cloth and warm water and dry.
- Take out and wash the oven accessories with warm water and a little washing-up liquid and dry thoroughly.
- Switch on the ventilation in the room or open a window.
- Heat the oven (to a temperature of 250°C, for approx. 30 minutes. Once oven has cooled wipe the inside of the oven with a soft damp cloth and dry.

Caution!

When heating the oven for the first time, it is a normal phenomenon to see smoke and peculiar smells. These should disappear in about 30 minutes. Hence the importance of ventilation in the room during the process.

Electronic programmer (for 8 function models)

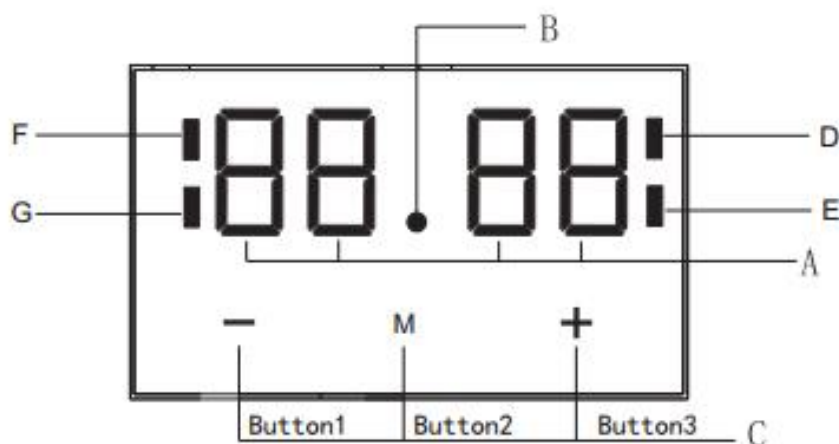

A - Display field

B - Seconds Icon

C - Buttons

D - Timer

E - Current time

F - Cooking time

G - End of cooking time

M - Function

- - To decrease the numbers on the digital display

+ - To increase the numbers on the digital display

Setting the time

1. At power on, display shows “12.00”, and  flashes.



2. The current time can be set using buttons 1 and 3. 5 seconds after the time has been set, the new data will be saved.

Timer

The timer can be activated at any time and with any function. The timer can be set from 1 minute to 23 hours and 59 minutes.

To set the timer:

1. Press button 2, until the display flashes '△'.



2. Set the timer using buttons 1 and 3.



3. 5 seconds after the time is set, the signal function '△' is on. Your setting is saved.
Or alternatively set the time and press button 2 immediately after to set the timer.

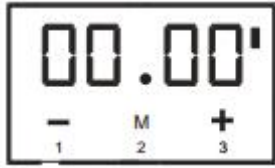

4. When the set time is up the alarm signal will be activated and the signal function will begin to flash again.





5. Press any button, the signal function '⏰', and alarm signal turn off. Or the alarm signal will be turned off automatically after 2 minutes.

Caution!

- Besides timer alarm, any other alarms can be turned off by pressing any button. If the alarm signal is not turned off manually, it will be turned off automatically after 2 minutes.

Semi-automatic operation

If the oven is to be switched off at a given time, or after a defined period, you should:

1. Set the oven function knob and the temperature regulator knob to the setting at which you want the oven to operate.
2. Press the function button, the oven will begin to work and the function signal  will start flashing.
3. Press buttons 1 or 3 to adjust the cooking time, within a range from 1 minutes to 10 hours.
4. Or press buttons “ 2 ” twice, then the display will show flashing  . Set the end time using buttons 1 and 3 .
5. The set time is introduced to the memory after 5 seconds.
6. When the set time has passed, the oven is switched off automatically, the alarm is activated.
7. Press any button, the alarm signal and the icon “  “will turn off. Or the alarm

signal will be turned off automatically after 2 minutes.

Caution!

The cooking time and end of cooking time range

Cooking time range: $0 < t \leq 10$ hours

End of cooking time range: current time $<$ end of cooking time \leq current time + 10 hours

End of cooking time = current time + cooking time

When using the semi-automatic operation, set either the cooking time or the end of cooking time.

If you set the cooking time to 0 or set the cooking time be the current time, the auto function will be off.

After the auto function is off, the cooking time is 0, end of cooking time and current time remains the same.

For example:

The current time is 2:00, want to oven work of 3 hours, end of cooking time is set to be 5:00 (2:00+3:00=5:00).



There are two methods to achieve this setting:

First method:

1. Set the cooking time using buttons 1 and 3.



2. End of cooking time automatically changes to 5:00.

Second method:







1. Set the end of cooking time using buttons 1 and 3.



2. Cooking time automatically changes to 3:00. 5 seconds after the setting, the auto function is on. 3 hours later, the current time shows “5:00” the alarm signal is activated.

Automatic operation

If the oven is to be switched on for a specified period of time and switched off at a fixed hour then you should set the cooking time and the end of cooking time:

1. Set the oven function knob and the temperature regulator knob to the setting at which you want the oven to operate.
2. Press button 2, the oven will begin to work and the function signal  will begin to flash.
3. Press button 1 and 3 to adjust the cook time, within a range from 1 minute to 10 hours.
4. And press button 2, then the display will flash . Set the cooking time using buttons 1 and 3.
5. The set time is introduced to the memory after 5 seconds. The function signals  and  are always on.
6. When the set time has passed, the oven is switched off automatically, the alarm signal is activated, and the signal function'  will turn off.
7. Press any button, the alarm signal and the  icon will all turn off. Or the alarm signal will be turned off automatically after 2 minutes.

Caution!

Work time = end of cooking time – cooking time

For example:

If the current time is 2:00; cooking time set to be 3hours; end of cooking time set to be 10:00, the work time will be 7:00 (7:00=10:00-3:00).



1. Set the cooking time to be "3:00" with button 1 and 3.



- 1.
2. Set the end of cooking time to be 10:00 with the button 3.



- 1.
3. 5 seconds after settings are selected the auto function is on.



- 1.
4. When it up to 7:00, the oven will begin to work



5. When it up to 10:00, the alarm signal is activated, the oven is switched off automatically..



Caution!

- If the cooking time set to be 0 or the end of cooking time set to be the current time, the auto function will be off.

Mechanical timer

1. Turn mechanical timer clockwise to the time position (between 10 and 120 minutes) you want.

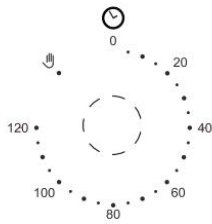

2. Turn function knob clockwise to the function position you want.

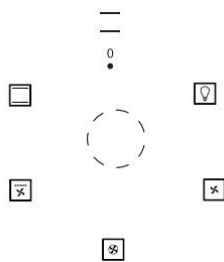

3. Turn temperature knob clockwise to the temperature position you want.

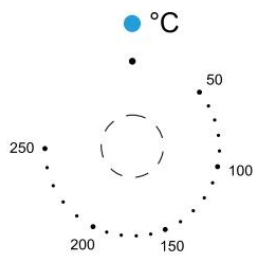

4. When oven reaches pre-set time, an alarm sound will be activated, which means the cooking is finished.

If you do not want the oven work controlled by the mechanical timer, turn the timer knob anti-clockwise way to the  position.

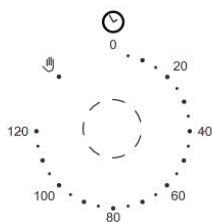

Caution!

Do not turn mechanical timer in a clockwise direction from 120 to “  “

Oven

- Oven is controlled by the function knob and the temperature control knob.

Caution!

- When selecting any heating function the oven will be switched on only after the temperature has been set by the temperature control knob.

Oven Functions



Bottom and top elements on

Setting the knob to this position allows the oven to be heated conventionally.



Top element on

(Full/combined grill)

When the "combined grill" is active enables grilling with the entire top element.

This function allows a higher temperature at the top of the cooking area, which causes more intense browning of the dish and permits larger portions to be grilled.

Warning!

- When using the Grill function it is required that the oven door is closed.
- When the grill is in use accessible parts can become hot. It is best to keep children away from the oven.



Circular element with fan on

This function heats the oven using a circular at the back of the oven, while the fan circulates the heat inside the oven.

Heating the oven up in this way permits even heat circulation around the dish in the oven.

Possibility to bake at two cooking levels simultaneously.



Fan on (Defrost)

With this function, the fan only works. You can cool the dish or the oven chamber or defrost food.



Fan and bottom element on

At this oven function, the oven activates the bottom element and fan.

The mode is useful for baking pastry and preparation of preserved fruit and vegetables.



Half top element on

Economy Grill

Use the economy grill to grill or brown small amounts of food. Pans best positioned on the top 2 racks for best results. Pre-heat the grill for 5 minutes before use.



Half top element and fan

The oven activates the grill element and fan. Use the grill with the oven door shut.

Caution!

When the functions with fan have been selected but the temperature knob is set to zero only the fan will be on.

With this function you can cool the dish or the oven chamber.



Separate oven lighting

By setting the knob to this position the lighting inside the oven is switched on

CLEANING AND MAINTENANCE

By ensuring proper cleaning and maintenance of your oven you can have a significant influence on the continuing fault-free operation of your appliance.

Before you start cleaning, the oven must be switched off at the mains, and you should ensure that all knobs are set to the "0" position. Do not start cleaning until the oven has completely cooled.

Oven

- The oven should be cleaned after each use.
- Cool the oven completely before cleaning.
- Never clean the appliance with pressurized hot steam cleaner.
- The oven chamber should only be washed with warm water and a small amount of washing liquid.
- Steam cleaning
 - -pour 250ml of water (1 cup) into a bowl placed in the oven on the first level from the bottom.
 - -Close the oven door.
 - -Set the temperature knob to 50°C, and the function knob to the bottom heater position.
 - -Heat the oven chamber for approximately 30 minutes.
 - -Open the oven door, wipe the chamber inside with a cloth or sponge and wash using warm water with washing-up liquid.
- After cleaning the oven chamber wipe it dry.

Caution!

- **Do not use cleaning products containing abrasive materials for the cleaning and maintenance of the glass front panel.**

Replacement of the oven light bulb

Before any maintenance is started involving electrical parts, the appliance must be disconnected from the power supply.

If the oven has been in use, let the oven cavity and the heating elements cool down before attempting any maintenance.

Changing the bulb

1. Unscrew the protective cover. We recommend that you wash and thoroughly dry the glass cover at this point.
2. Carefully remove the old bulb and insert the new bulb suitable for high temperatures having the following specifications: 220-240V, 50Hz, 25W, G9 fitting. Refit the protective cover.

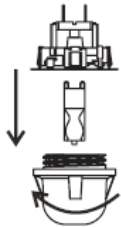

IMPORTANT

- **Never use screwdrivers or other utensils to remove the light cover. This could damage the enamel of the oven or the lamp-holder. Remove only by hand**
- **Never replace the bulb with bare hands as contamination from your fingers can cause premature failure. Always use a clean cloth or gloves.**

Please note:

The bulb replacement is not covered by your guarantee/warranty

Door removal

In order to obtain easier access to the oven chamber for cleaning, it is possible to remove the door.

1. Tilt the safety catch part of the hinge upwards.
2. Close the door lightly until it comes to stop
3. Lift and pull it out towards you.

In order to fit the door back on, follow the process in reverse.

When fitting, ensure that the notch of the hinge is correctly placed on the protrusion of the hinge holder. After the door is fitted to the oven, the safety catch should be carefully lowered down again. If new the safety catch is not set it may cause damage to the oven when closing the door.

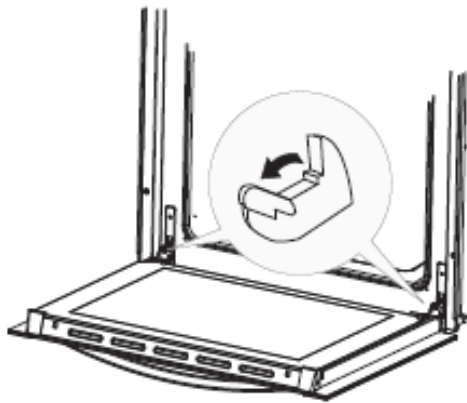

Tilting the hinge safety catches

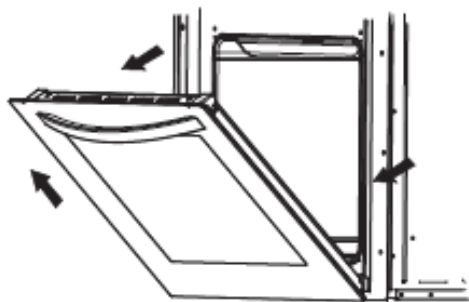

Door removal

▷ **Removal of the internal glass panel**

Press the symbol "↑" and outward the plastic latch that is in the corner at the top of the door. Next take out the glass from the second blocking mechanism and remove. After cleaning, insert and block the glass panel, and insert in the blocking mechanism.

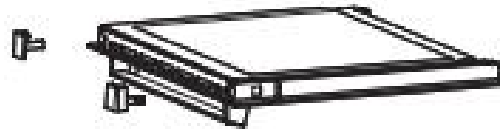

Removal of the internal glass panel

▷ **Install door**

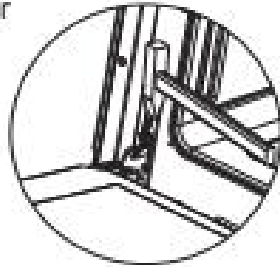

OPERATION IN CASE OF EMERGENCY

In the event of an emergency, you should:

- Switch off all working units of the oven
- Call the service centre
- Some minor faults can be fixed by referring to the instructions given in the table below. Before calling the customer support centre or the service centre check the following points that are presented in the table.

PROBLEM	REASON	ACTON
1. The appliance does not work	Break in power supply	Is the power supply switched on Check the household fuse box, if there is a blown fuse replace it with a new one
	Incorrect function	Check if function knob and temperature knob is set to the correct position.
2.The programmer display is flashing "0.00"	The appliance was disconnected from the mains or there was a temporary power surge/outage.	Set the current time on the clock (see use of the programmer)
3. The oven lighting does not work.	The bulb is loose or damaged.	Tighten up or replace the blown bulb (see cleaning and maintenance)

BAKING IN THE OVEN

Oven guide levels

Baking pans and accessories (wire racks, baking tray, etc) may be inserted into the oven in 5 guiding levels.

Appropriate levels are indicated in the tables that follow.

Always count levels from the bottom upwards!

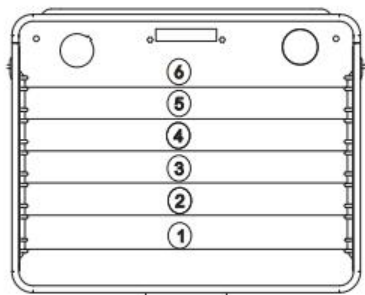

IMPORTANT

Tables below a guidelines only.

Baking Table

Type of pastry	Guide level(from down upwards)	Temp (°C) 	Guide level(from down upwards)	Baking time (in min)
Sweet pastry				
Sponge cake/ marble cake	2	170-180	2	60-80
Victoria sponge	2	160-180	2	65-80
Base for a layer cake	2-3	170-180	2-3	20-30
Sponge layer cake	2	170-180		30-40
Fruit cake(crispy base)			2-3	60-70
Cheesecake (shortcrust)			2	60-90
Teacake	2	160-180	2	40-60
Bread (e.g.wholegrain bread)	2	210-220	2	50-60
Fruit cake(crispy base)	3	170-180	2	35-60
Fruit cake(with yeast)			2	30-50
Crumble cake	3	160-170		30-40
Sponge roll	2	180-200		10-15
Piza (thin base)	3	220-240		10-15
Piza (thick base)	2	180-210		30-50
Buns	3	160-170	2	10-30
Puff-pastry	3	180-190	2	18-25
Meringues	3	90-110		
Choux buns			2	35-45

Roasting Table

Type of meat	Guide level(from bottom up)	Temp (°C) 	Roasting time (in min)	Roasting time (in min)
Beef				Per 1 cm
Roast beef or file rare			3	12-15
Oven warmed up juicy(“medium”)			3	15-25
Oven warmed up “well done”			3	25-30
Oven warmed up Roast joint	2	160-180	2	120-140
Pork				
Roast joint	2	160-180	2	90-140
Ham	2	160-180	2	60-90
Fillet			3	25-30
VEAL	2	160-170	2	90-120
LAMB	2	160-180	2	100-120
VENISON	2	175-180	2	100-120
POULTRY				
Chicken	2	170-180	2	50-80
Goose(approx.2kg)	2	160-180	2	150-180
Fish	2	175-180	2	50-80

Grill table

Type of meat for grill	Weight (in grams)	Guide level (from bottom up)	Temp (°C) 	Grill time (in min.)
Meat and sausages				
2 beefsteaks, rare	400	5	240	14-16
2 beefsteaks, medium	400	5	240	16-20
2 beefsteaks, well done	400	5	240	20-23
2 pork scrag filets	350	5	240	19-23
2 pork chops	400	5	240	20-23
2 veal stakes	700	5	240	19-22
4 lamb cutlets	700	5	240	15-18
4 grill sausages	400	5	240	9-14
2 slices of meat cheese	400	5	240	9-13
1 chicken, halved	1400	3	240-250	28-33(1.side) 23-28(2.side.)
Fish				
Salmon fillets	400	4	240	19-22
Fish in aluminium foil	500	4	230	10-13
Toast				
4 slices of white bread	200	5	240	1,5-3
2 slices of whole meal	200	5	240	2-3
Toast sandwich	600	5	240	4-7
Meat/poultry				
Chicken	1000	3	180-200	60-70
Pork roast	1500	3	160-180	90-120
Pork scrag	1500	3	160-180	100-180
Pork knuckle	1000	3	160-180	120-160
Roast beef/ beef fillet	1500	3	190-200	40-80

TECHNICAL INFORMATION

Model	OX7-2-6S-5	OX7-2-6S-8
Voltage rating	220-240V 50Hz	220-240V 50Hz
Total power	2000W	2000W