

Installation and Operating Instructions

Model:
OV-M1-6S-9

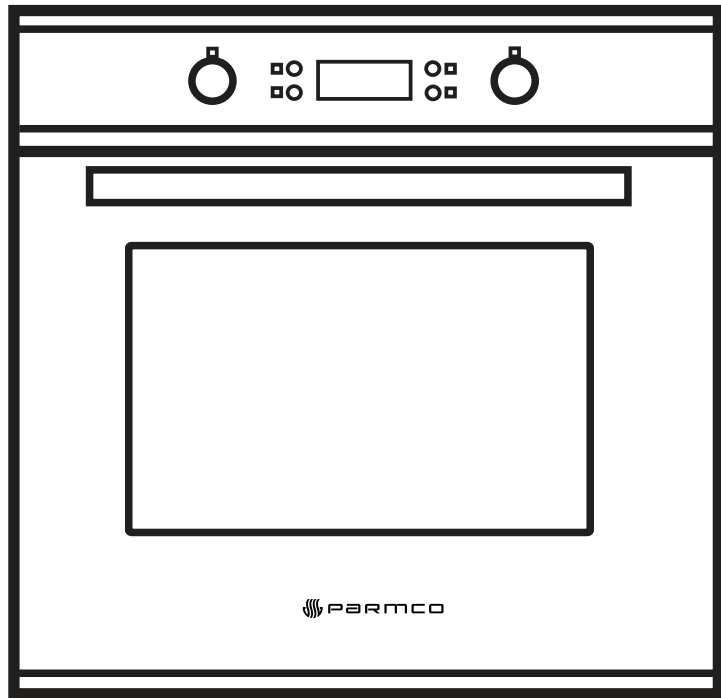

For your convenience, we recommend to attach the serial number label HERE.

As part of Parmco Appliances commitment to improving and updating product ranges, we reserve the right to alter, change and update technical specifications and appearance attributes of all Parmco Appliances products. E&OE.





PARMCO

Dear Valued Customer,

Thank you and congratulations on purchasing your new Parmco appliance.

All Parmco products are made to the highest quality and design standards. We are sure you will enjoy your new appliance.

As a note, please read through these instructions carefully, as these will assist you in gaining a complete understanding of the functions and features offered by your appliance.

Please take special note of all detailed technical information and installation instructions. It is essential that you only allow a qualified technician to install this appliance to ensure the safety and reliability of this appliance.

Furthermore, not using appropriate personnel to install this appliance may affect any future warranty claims lodged, so please check with Parmco Appliances before any installation is carried out.

We hope you enjoy your new appliance. If you would like to find out more about this product or any other products in Parmco's extensive range, visit us on the web at www.parmco.co.nz.

Regards,

The Parmco Team



Cook



Vent



Clean



Cool



Laundry

INDEX

	PAGE
Important Safety Information	
Before Using this Appliance	2
For your Safety	2
Product description	3
Cooking Functions	5
Operating Instructions	6
Cooking Guide	9
Maintenance	10
Installation Instructions	12
Accessories	16



IMPORTANT NOTE

It is the law in New Zealand that this appliance must be installed by authorised persons. The installation must comply with all the appropriate New Zealand Standards and Regulatory Requirements with particular reference to the New Zealand Electrical Standards.

Any attempt to install this or any other Parmco product without an authorised person could result in damage to the product and a possible health hazard. Not having an authorised person install this appliance may result in all associated warranties from Parmco Appliances being null and void.

IMPORTANT SAFETY INFORMATION

We recommend that for best performance and to extend the life of your appliance you read the instructions in this owner's manual thoroughly before using your new appliance. It will provide you with all the information you need to ensure its safe installation, proper use and maintenance. Retain this owner's manual for future reference.

To maintain the efficiency, and safety of this appliance we recommend the following:

BEFORE USING THIS APPLIANCE

Read the instructions thoroughly

- Remove all plastic protective films on the appliance before operating the appliance.
- Remove the plastic film on the oven glass door (when provided).
- To condition the oven for its first use, it is necessary to allow oils and residues used to protect the appliances during manufacturing to burn off. Heat the empty oven at maximum temperature for 45 minutes. This allows unpleasant smells and smoke from protective oils used during manufacture and from new thermal insulation to burn off.
- Allow the unit to cool off and wash the oven out with soapy water and then rinse.

FOR YOUR SAFETY

- This appliance is designed for non-commercial, household use only and must not be altered in any way.
- This appliance can only be used safely when it is correctly connected to an efficient earthing system in compliance with New Zealand Electrical Standards requirements.
- Before maintenance or cleaning, always ensure that the appliance is disconnected from the mains.
- Always use oven gloves to remove and replace cookware in the oven.
- Packaging items such as plastic bags, polystyrene, nails, etc that this appliance is delivered in are potentially dangerous, and therefore appropriate measures must be taken to prevent children from coming into contact with them.
- This appliance must only be used by adults. Make sure that children do not touch the controls or play with the appliance. Young children should be supervised to ensure they do not play with the appliance.
- Do not allow children to sit on or play with the oven door.
- Do not use the drop down door as a stool to reach overhead cabinets.
- This appliance is not intended for use by persons (including children) with reduced physical, sensory, mental capabilities, or lack of experience and knowledge, unless they have been given supervision or instruction concerning the use of this appliance by a person responsible for their safety.
- During use the appliance becomes hot. Care should be taken to avoid touching heating elements inside the oven.
- Keep the appliance thoroughly cleaned. Food residues may cause fire risks.
- DO NOT use a steam cleaner to clean this appliance.

- NEVER line the oven with aluminium sheets as doing so may damage the enamel and elements.
- WARNING: Accessible parts may become hot during use. To avoid burns young children should be kept away.
- Do not use harsh abrasive cleaners or sharp metal scrapers to clean the oven door glass since they can scratch the surface, which may result in shattering of the glass.
- After using the appliance, please ensure that all controls are in the “OFF” position.
- Avoid touching the oven with wet body parts.
- Avoid improper or dangerous use of this appliance.
- Do not obstruct the ventilation or heat dissipation slots.
- Do not allow power cables of other appliances to come into contact with hot parts of this appliance.
- This appliance is intended for indoor use only. Avoid exposing the appliance to atmospheric elements such as direct sunlight and rain.
- DO NOT USE OR STORE FLAMMABLE MATERIALS IN THE APPLIANCE OR NEAR THIS APPLIANCE.



Steam and Condensation

- Often owners of new ovens will see a higher level of steam and condensation than they are used to in their previous appliance. This is normal and contributes to keeping the food moist during cooking. The amount of condensation will depend on the type of food (fresh, defrosted, frozen) being cooked and the cooking style (water in the roasting dish). Climatic conditions also contribute to the generation of condensation.
- When food is heated it produces steam in the same way a boiling kettle does. When steam comes into contact with the oven door glass it will condensate and produce droplets. To reduce condensation, ensure that the oven is well heated before placing food in the oven cavity. **Oven pre-heating is necessary before any cooking!**
- It is normal for steam to escape the oven when opening the door. To reduce the build up of condensation pre heat the oven for longer periods and occasionally open the door and carefully wipe away the condensation. Adjusting your cooking practices will also ensure a minimum build up of condensation.

PRODUCT DESCRIPTION

This multi-function oven combines the advantages of traditional convection ovens with a modern fan assisted oven in a single appliance. It is an extremely versatile appliance that allows you to choose easily and safely between different cooking modes.

It is important to remember that this oven may perform differently to the way your previous appliance worked. To obtain the best cooking results, please experiment with temperature, rack height and cooking times.

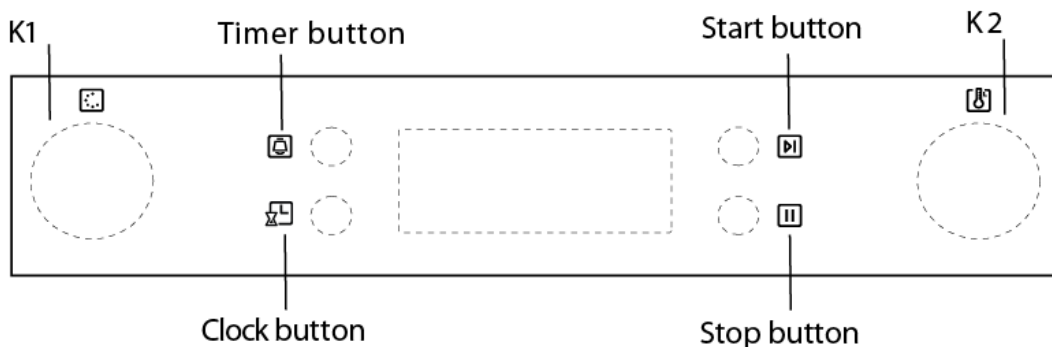

- **Positioning the Oven Trays & Shelves**

The deep tray and wire shelves can be located in any of five height positions. When fitting the wire racks or trays please ensure that they are located between the two wires that are closest together on the side racks. Wire racks have a safety stop so that they cannot be fully withdrawn by accident. To fully withdraw the wire racks simply lift the front edge slightly and withdraw the rack from the oven. The deep tray does not have a stop position and can be fully withdrawn from the oven without interruption.









BE CAREFUL NOT TO ACCIDENTALLY FULLY WITHDRAW THE TRAY.

The first time you use your appliance, we recommend that you set the temperature to "MAX" set the cooking function knob to a cooking mode, and leave the oven operating empty for approx 45 minutes. Then turn off the appliance and allow it to cool. Any odours that may be detected during this initial use are due to the evaporation of substances used to protect the appliance during manufacture and storage.

Note:

Place the tray provided on the bottom shelf position to prevent any spillages from dripping onto the bottom of the oven. **Never place anything (including foil and oven trays) directly onto the bottom of this oven during operation as this could damage the enamel.** Only place your cookware (dishes, trays, aluminium foil etc) on the oven shelves provided with this appliance.



COOKING FUNCTIONS

Symbol	Function description
	Oven light: Turns on the oven light. Please note this function does no cooking.
	Defrost: The air circulation at room temperature enables quicker thawing of the frozen food without using any heat. It's a gentle but quick way to speed up the defrost time.
	Bottom heat: A concealed element at the bottom of the oven provides gentle heat to the base of food without browning. This is ideal for slow cooking dishes such as casseroles and stews. The temperature can be set within the range of 60-120 C°; the default temperature is 60°
	Conventional cooking: The top and bottom elements are on at the same time. The oven needs to be pre-heated first to the desired temperature. This function is ideal for cooking a single layer of foods such as cakes, breads, etc. To achieve best results, place the food in the centre of the oven. The temperature can be set between 50-250 C°; the default temperature is 220C°
	Conventional cooking with fan: Both top and bottom elements plus the fan are working at the same time to provide even more heat, saving up to 30-40% energy. This function is suitable for big roasts using a high cooking temperature or grilling. The temperature can be set between 50-250C°; the default temperature is 220C°.
	Radiant Grill: The inner grill element switches on and off to maintain temperature. For best results, use the top shelves for small items and the lower shelves for larger items. The temperature can be set between 180-240C°; the default temperature is 210C°. Always grill with the door closed.
	Double grill: The inside radiant element and top element are both operating. The temperature can be set between 180-240C°; the default temperature is 210C°. Always grill with the door closed.
	Double grill with fan: The inside radiant element and top element are working together with the fan. The temperature can be set between 180-240C°; the default temperature is 210C°. Always grill with the door closed.
	Fan forced cooking: An element around the circulation fan provides heat for convection style of cooking. In the fan forced mode, the fan automatically comes on to circulate heat evenly throughout the oven. The temperature can be set between 50-240C°; the default temperature is 180C°.

OPERATING INSTRUCTIONS

1. SETTING THE CLOCK

After the unit is connected to power, the symbols 0:00 will display on the control panel.

- Press  and the hour indicator will flash.
- Rotate "K2" clockwise to adjust the hour digits, the time should be within 0-23 hrs.
- Press  and the minutes indicator will flash.
- Rotate "K2" clockwise to adjust the minutes digits, the time should be within 0-59 min.
- Press  to finish the clock settings. " : " will flash.





Note: The clock is 24 hours, and must be set for the oven to function!

2. SEETING FUNCTION AND TEMPERATURE

- Rotate "K1" to choose the desired cooking function and the indicator will come on.
- Rotate "K2" to adjust the temperature.
- Press  to confirm the start of cooking. The default temperature for that cooking function will be displayed. The selected temperature will flash until the temperature has been reached, then it will beep and stop flashing.



Note:

The step quantities for time adjustments of the coding switch are:

- 0 -- 0:30min: step 1 minute
- 0:30--9:00 hours: step 5 minutes
- The step quantity for temperature adjustment is 5° C, and for the grill function is 30° C.
- Rotate "K1" to adjust the cooking time when cooking begins, then press  to start cooking. If  is not pressed within 3 seconds, the oven will revert to the previous time and continue cooking.
- Rotate "K2" to adjust the temperature when cooking begins. The corresponding indicator will flash, then press  to start cooking. If  is not pressed within 3 seconds, the oven will revert to the default temperature setting.



3. ENQUIRING FUNCTION

During cooking, you can select the enquiring function; after 3 seconds the oven will return to the current working state.



- During cooking, press  to check the current time.
- If the clock was set, press  to check the remaining time.

4. CHILD LOCK FUNCTION

- **To LOCK:**

Press the  and  simultaneously for 3 seconds. A long beeping sound will indicate the child lock function has been activated and the  symbol will illuminate.

- **To UNLOCK:**



Press the  and  simultaneously for 3 seconds. A long beeping sound will indicate the child lock function has been deactivated and the  symbol will disappear.



Note: To quickly stop cooking while in cooking mode, press the stop button.

5. TIMER FUNCTION





The oven has a 9 hours timer function. The timer can only be used when the oven is in standby mode and the clock is set.

To set the timer, follow the instructions below:

- Press the timer button 
- Rotate "K2" to set the hour.
- Press the timer button again 
- Rotate "K2" to set the minutes.
- Press  to start the time.

Note: After the time is set, the oven buzzer will sound 10 times, and the  symbol disappears. You can cancel the timer by pressing the  button.

6. START/PAUSE/CANCEL FUNCTION

- If the cooking time has been set, press  to start cooking. If the cooking is paused, press  to resume cooking.
- During cooking, press  once to pause cooking. Press  twice to cancel the cooking.

7. ENERGY SAVING



To save energy the display can be turned off.

- While in standby and timer mode, press  for three seconds. The LED display will go off and set in the energy-saving mode.
- If there is no operation in 10 minutes while in standby mode, the LED display will turn off into the energy saving mode.
- While the oven is in energy-saving mode, you can press or rotate any key to exit this mode; the display will turn on.



8. PROGRAMMABLE COOKING FUNCTION

You can set the oven to turn on at a specific time, cook for a specific time period with a specific cooking function and temperature. The clock must be set to the correct time of day for this function to work correctly.



- **Step 1 : Set the correct time of day.**

- (1) Push the  button to select the hour. Turn the K2 knob to desired time.
- (2) Push the  button to select the minutes. Turn the K2 knob to desired time
- (3) Push the  button to set the clock time.

- **Step 2: Set the desired start time for the cooking to begin**

- (1) Push the  button to select the hour. Turn the K2 knob to desired time.
- (2) Push the  button to select the minutes. Turn the K2 knob to desired time

- **Step 3 : Select the cooking function**





- (1) Turn the K1 knob to select the desired cooking function
- (2) Press the  button to set the cooking function and bring up the time. You will notice  symbol appears in the bottom left of the screen.
- (3) Turn the K1 knob anticlockwise until the desired cooking duration is reached.
- (4) Turn the K2 knob until the desired cooking temperature is selected.
- (5) Press the  button to start the function.

The oven will automatically turn on at the set time and cook for a set duration using the selected cooking function and temperature. The oven will then shut off.

Note:

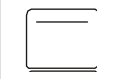
- The oven lamp will be on for all functions.
- Once the cooking programme has been set, but the  button is not pressed within 5 minutes, the current time will display and the cooking setting will be cancelled.
- The beeper sounds when effectively pressed; otherwise there will be no response.
- The beeper will sound five times to remind you when the cooking time has finished.

COOKING GUIDE

Selector knob setting	Food Type	Weight (in KG)	Rack height From bottom	PreHeat Time (mins)	Temp Deg C	Cook Time (mins)
Traditional Cooking 	Duck	1	3	15	200	65-75
	Roast Beef	1	3	15	200	70-75
	Roast Pork	1	3	15	200	70-80
	Roast Lamb	1	3	15	200	70-80
	Biscuits		3	15	180	15-20
	Tarts		3	15	180	30-35
Browning 			3/4	15	220	
Grill 	Fish	1	4	5	MAX	8-10
	Kebabs	1	4	5	MAX	6-8
	Vegetables	1	3/4	5	MAX	10-15
	Veal	1	4	5	MAX	15-20
	Cutlets	1	4	5	MAX	15-20
	Hamburgers	1	4	5	MAX	7-10
	Toasted sandwiches		4	4	MAX	2-3
Fan Assisted Grill 	Chicken	1.5	3	5	MAX	55-60
Baking 	Tarts	0.5	3	15	180	20-30
	Fruit cakes	1	2/3	15	180	40-45
	Sponge cake	0.5	3	15	160	25-30
	Small cakes On 2 racks	0.6	2-4	15	190	20-25
	Biscuits on 3 racks	0.7	1-3-5	15	180	20-25
	Meringues on 3 racks	0.5	1-3-5	15	90	180

Please note the above is a guide only and you will need to vary temperatures, times and rack height combinations to achieve the results you want.

MAINTENANCE

- **Cleaning the oven:**

Before cleaning your appliance or performing maintenance, make sure that the cooking mode selection knob and cooking temperature selection knob is set to the “OFF” position. To extend the life of your oven, it must be cleaned frequently.

The inside of the oven should be cleaned soon after use when the oven is still warm (not hot) with warm soapy water. The soapy water should be rinsed away and the interior dried thoroughly. Avoid using abrasive detergents, scourers, acidic cleaners etc, as these may damage the enamel. If stains are particularly tough to remove, use cleaners specifically recommended to clean ovens and follow the instructions provided. **Never use a steam cleaner to clean the inside of this oven.**

If you are using the oven for an extended period of time, or if you are cooking dishes that contain a lot of water, condensation may form on the oven door. Dry it using a soft cloth and try reducing the cooking temperature.

There is a rubber seal surrounding the oven. Check the condition of the seal on a regular basis. If necessary, clean it but avoid using abrasive products or objects to do so. Should it become damaged please contact Parmco Appliances service department. We recommend you avoid using the oven until it has been repaired.



Never place anything (including foil and oven trays) on the bottom of the oven when it is in operation as this may result in damage to the enamel.

Clean the glass door using non-abrasive products or sponges and dry it with a soft cloth. Do not use abrasive cleaners or sharp scrapers to clean the oven door glass since they can scratch the surface and may result in shattering of the glass.

- **How to remove the oven door**

You can remove the oven door for better access to the oven when cleaning.

- Open the door fully.
- Locate the hinge assembly (1).
- Lift the hinge tab to the open position (2).
- Gently close the door until the hinge assembly is against the door (3).
- Lift the door up and out at the same time.
- To replace the door reverse the above procedure, making sure that the hinge is correctly located on the small rebate in the hinge arm (4).

1

2

3





- **Replacing the Oven Lamps**



WARNING: Ensure that the appliance is turned off before replacing the oven lamp/s to avoid the possibility of electric shock.

Remove the glass cover of the lamp-holder as shown below.

Remove the lamp and replace with a lamp resistant to high temperatures (300°C) with the following characteristics.

- Voltage 220 - 240V
- Wattage: 25W
- Type: E14

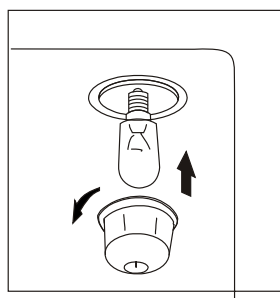

Disposal

Parmco has a commitment to being environmentally responsible. To avoid potential negative impacts on the environment, please ensure that this appliance is disposed of correctly. This product must not be treated as household waste. Instead it should be handed over to an appropriate collection point for recycling of electrical, electronic and steel components. Disposal should always be carried out in an environmentally appropriate manner.

For more detailed information about treatment, recovery and recycling of this product, please contact your local City Council office.

IMPORTANT NOTE

It is the law in New Zealand that this appliance must be installed by authorised persons. The installation must comply with all the appropriate New Zealand Standards and Regulatory Requirements, with particular reference to the New Zealand Electrical Standards.

Any attempt to install this or any other Parmco product without an authorised person could result in damage to the product and possible health hazard. Not having an authorised person install this appliance may result in all associated warranties from Parmco Appliances being null and void.

INSTALLATION INSTRUCTIONS

- Installation of this appliance and its connection to the electrical mains must only be carried out by authorised personnel. Before any service procedure, it is important to ensure that the appliance is DISCONNECTED from the electrical mains.
- DO NOT MODIFY THIS APPLIANCE.
- After removing the appliance from the packaging, make sure that it is undamaged. Otherwise, contact your dealer before operating this appliance.
- Make sure that this appliance is installed in accordance with the ventilation requirements.

NOTES TO THE AUTHORISED INSTALLER



This appliance shall only be installed by an authorised person. This appliance shall only be installed in complete accordance with the Electrical Standards of New Zealand. All local regulations, building code requirements and all other statutory requirements must be met.

Data Label

The data label is located at the rear of the appliance. A duplicate data label is supplied to adhere to a suitable accessible area next to the appliance. The data label on the appliance must NEVER be removed.

Before any procedure, it is important to check that the appliance is DISCONNECTED from the electrical mains. Parmco declines all responsibility for any damage deriving from installations that are in breach of the regulations in force or from failure to comply with these installation instructions.

ELECTRICAL CONNECTION

The appliance comes fitted with an approved 15 amp cord which may be connected to a correctly earthed socket outlet. It is necessary that all installation and connections are carried out by qualified personnel and that the connections meet all New Zealand Regulatory Requirements.

Before connecting to the mains make sure that:

- The protection device, feed cable and socket are suitable to withstand the maximum load requirements as detailed on the rating label.
- The supply system is regularly grounded as per New Zealand Regulations
- The omnipolar switch can easily be reached after the appliance is installed.
- After connection of the appliance to the mains, ensure the cord does not come into contact with any parts of this appliance subject to heating.
- Never use reductions, shunts, adaptors which can cause overheating or burning.

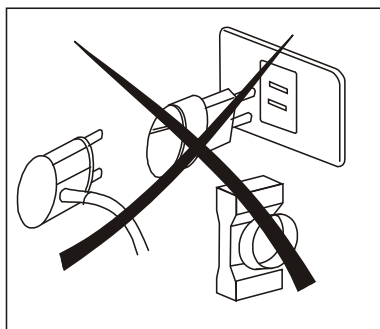

When handling this oven it is essential that you always use the purpose provided handles recessed into the sides of the oven. This will ensure that the oven carcass and door is not stressed by lifting. DO NOT use the door handle when lifting this appliance into position. This could result in damage to the hinges.

INSTALLATION INTO CABINETS

- **Securing the oven to the cabinet**

1. Fit oven into the cabinet recess.
2. Open the oven door.
3. Secure the oven in the kitchen cabinet using the two instance holders "A" which fit the holes in the oven frame cavity, then use the two screws "B"

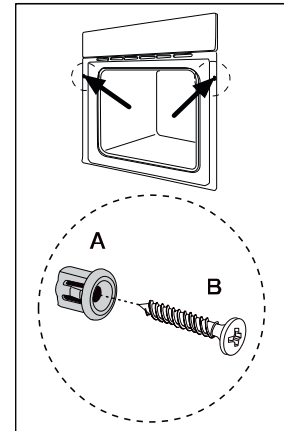

- **Electrical connection**

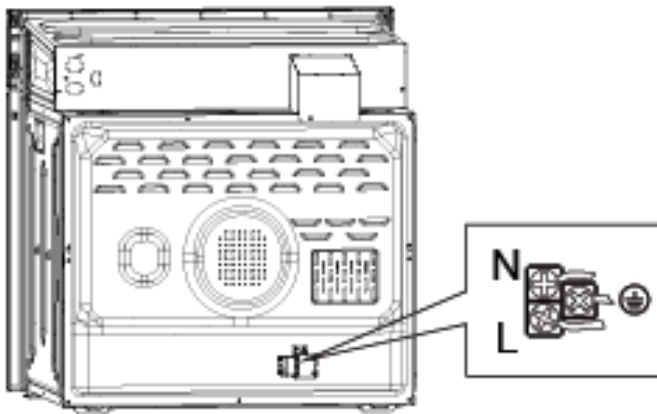

- **Installation**

Please note the rear panel of the cabinetry must be removed to ensure adequate ventilation.

The power switch or socket that connects to the appliance should not be located in the installation housing, but rather in an adjacent cabinet or above the worktop.

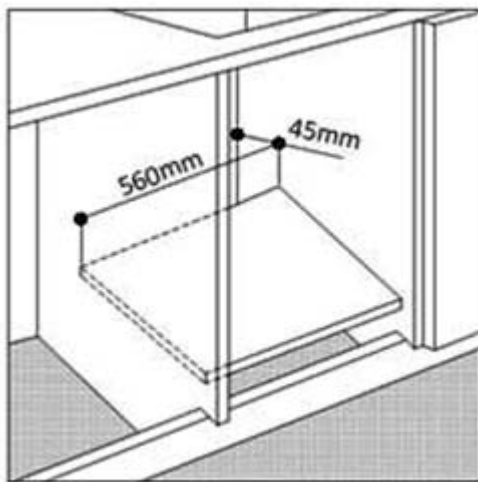
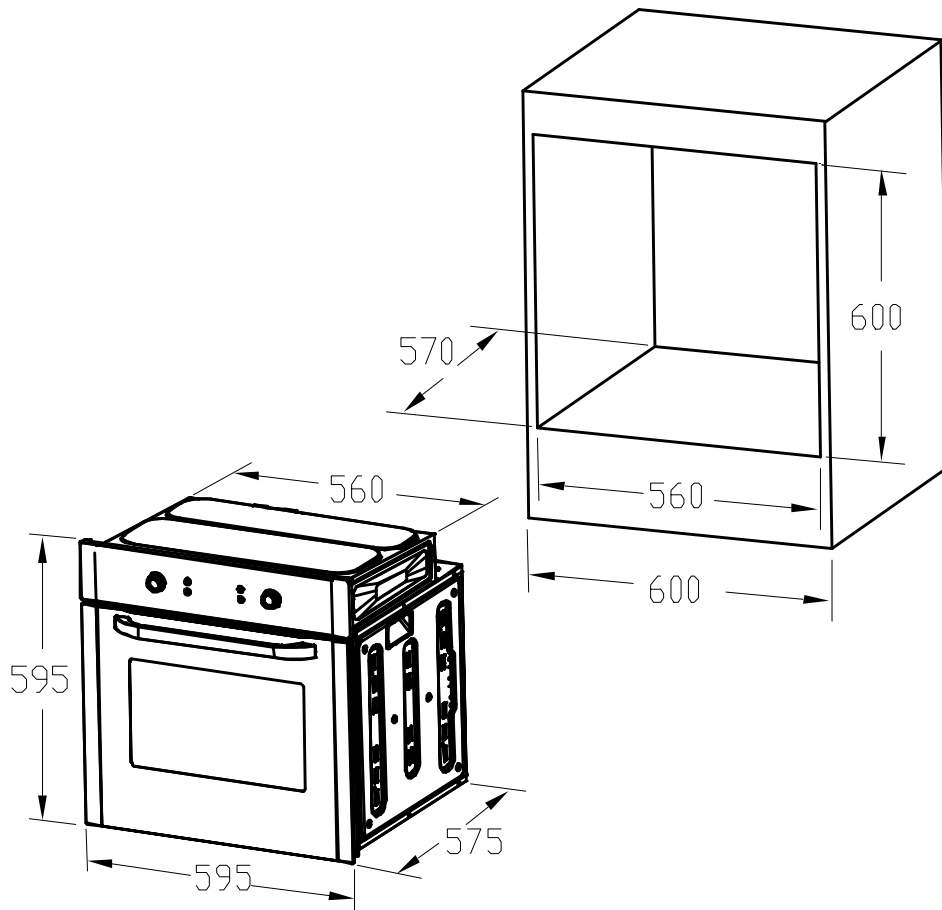

In order to ensure adequate ventilation, the back of the cabinet unit must be removed. If the oven will rest on a continuous panel there must be an aperture of at least 560mm wide by 45mm deep from the rear of the cabinet.



The panels that are immediately adjacent to the oven must be of a material that has heat resistant qualities. In particular, cabinets with veneer finishes must be assembled with glues that can withstand temperatures of up to 100°C. Special attention must be paid to the edge banding finish on the cabinetry. Special care must be taken with vacuum applied veneers commonly referred to as “thermowrap”. If in doubt, always refer to the technical data supplied by the kitchen cabinetry manufacturer.

ACCESSORIES

Wire shelves: For grilling dishes, to support cake pans or roasting dishes.

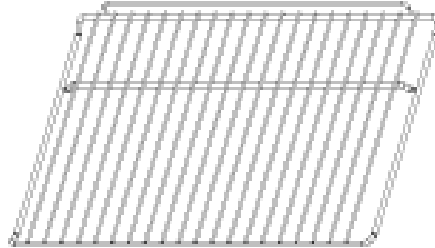

Slider bracket: These shelves support the rails on the right and left hand side of the oven and can be removed for cleaning.

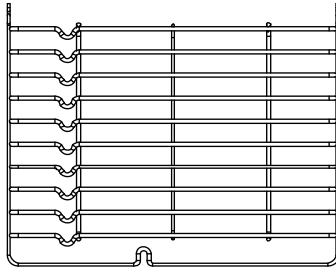

Drip pan: To be used for grilling and to collect fat/spillage of meat juices.

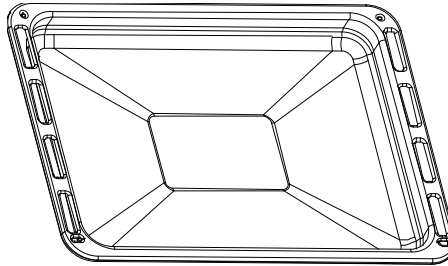

Correct placement of the shelves between the side rails is imperative for safety operation. This will ensure that during the tray or shelf removal, hot food items will not slide out!

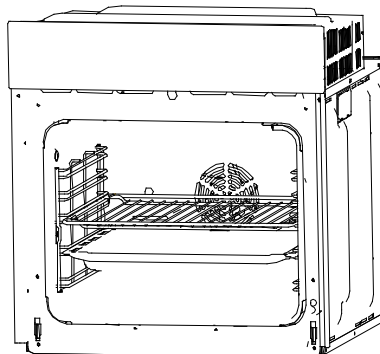

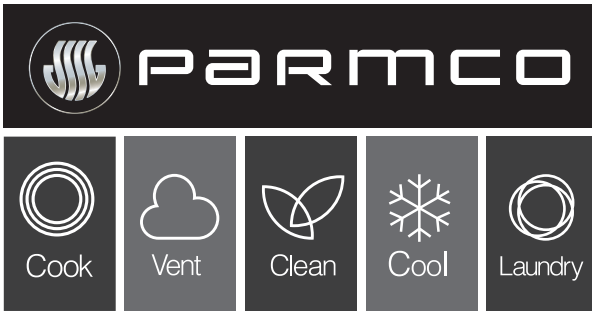

p: 09 573 5678
 f: 09 573 5699
 e: sales@parmco.co.nz
 w: www.parmco.co.nz

Parmco Appliances extended 5 year warranty



The Warranty:

- Subject to the terms and conditions contained within this warranty, if the product is not of Acceptable Quality (as defined in the Consumer Guarantees Act) within 5 years of the date of original purchase, then Parmco Sales undertakes to repair or, at its sole discretion, replace the product.
- The warranty does not cover the costs of transport, mileage or travelling time if the product is located beyond 30km of a recognised Service Agent.
- This warranty is offered as an extra benefit, and does not affect other legal rights, which can not be modified or excluded by agreement.
- This warranty only applies to goods supplied and installed in the North and South Islands of New Zealand.
- The provisions of this warranty are in addition to the rights and remedies available to consumers under the Consumer Guarantees Act 1993.
- Products purchased as seconds or thirds may or may not carry a warranty. Please check with your reseller at the time of purchase for the warranty period being offered.

The Warranty is not valid:

- If the product is not installed and operated in accordance with the operating instructions.
- If the product is not installed to comply with the electrical, gas, plumbing and other Regulations and Codes of Practice in New Zealand.
- If the product is operated on voltages or frequencies outside the normal range for domestic appliances in New Zealand.
- If the product is not used in normal domestic use, or if it is used in a business as defined in the Consumer Guarantees Act.
- If any serial number has been removed or defaced.
- If proof of date of purchase is not supplied, except at the sole discretion of Parmco Sales. Proof of purchase can be for the product itself, or if installed with a kitchen or house then proof of purchase can be from a Parmco reseller of products supplied by Parmco.
- If the products are purchased in a second hand condition from other parties (including but not limited to TradeMe, Sella, etc.)

Liability under this warranty will not be accepted for:

- Wear and tear from normal domestic use.
- Damage in transport.
- Damage caused to the product by neglect, abuse, negligence, wilful act or misuse.
- Any costs associated with the repair, replacement, removal or reinstallation of products installed in a damaged condition.
- Any defect caused by accident, misuse, neglect, tampering with or unauthorised modifications of the appliance or any attempt at internal adjustment or repair by any person other than an Authorised Service Agent.
- Service calls that relate principally to the following:
 - Instruction on how to use the product.
 - Repair or replacement of house fuses, electrical wiring, gas fitting or plumbing.
- Wear and tear caused by normal use of the product.
- Normal or scheduled maintenance including blocked filters or ducting.
- Consumable items such as light bulbs.
- Any damage to ceramic glass hobs caused by spills when cooking.
- Any breakage or damage of glass items.
- Any damage caused by non recommended product used for cleaning, maintaining, lubricating or similar.
- Any aspect relating to the installation of the product, or damage caused during installation including blocked access for repair.
- Any third party (including reseller) or consequential loss or damage (direct or indirect) however arising.

Product _____ Date of purchase _____

Dealer / Retailers Name _____

Please retain this Warranty card together with receipt or other proof of purchase date when seeking service during the warranty period

Please contact Parmco at 09 573 5678 if your appliance needs servicing under warranty. Please have your model number and proof of purchase ready. Warranty repairs must be authorized by Parmco.

Subject to updates without prior notice, please visit www.parmco.co.nz for the latest version.

E & O.E. 727626112014